

licht*jahr* 2009

Gutes Licht zum
guten Wohnen



LEUCHTENSERIEN

88001 Nickel matt, Glas weiß satiniert, H. 52 cm, inkl. LM 150 W, R7s, 118 mm, HV

88002 Nickel matt, Glas weiß satiniert, mit Dimmer, H. 56 cm, Fuß-Ø 17 cm, inkl. LM 150 W, R7s, 118 mm, HV

88003 Nickel matt, Glas weiß satiniert, mit Dimmer, H. 183 cm, Fuß-Ø 28 cm, inkl. LM 2x150 W, R7s, 118 mm, HV

88004 Nickel satiniert, Opalglas, Ø 70 cm, inkl. LM 5x40 W, G9, HV

88005 Nickel matt, Glas weiß satiniert, H. 140 cm, L. 110 cm, inkl. LM 2x150 W, R7s, 118 mm, HV

88006 Schwarz, Schirm innen goldfarbig mit ausgestanztem Muster, mit Fußschalter, Ø 35 cm, H. 150 cm, LM 2x60 W, E27

88007 Schwarz, Schirm innen goldfarbig mit ausgestanztem Muster, Ø 40 cm, H. 20 cm, Gesamt-H.120 cm, LM 3x60 W, E27

88008 Chrom, Glas weiß glänzend mit Ornamenten, L. 100 cm, H. 12 cm, Abhängung 130 cm, LM 5x40 W, E14

88009 Chrom, Glas weiß glänzend mit Ornamenten, L. 52 cm, B. 52 cm, H. 12 cm, LM 3x60 W, E27

Unverbindliche Preisempfehlungen. Alle Preise ohne Leuchtmittel, wenn nicht anders angegeben, einschließlich gesetzl. Mehrwertsteuer. Preis- sowie Modelländerungen in gleicher oder verbesserter Qualität vorbehalten.

Unser Sortiment ist größer als unser Lager. Die in diesem Prospekt angebotene Ware ist teilweise bei uns vorrätig, teilweise kurzfristig auf Bestellung lieferbar.

Leuchtmittel inkl. = 

In Deutschland gefertigte Leuchten = 

Energiesparleuchten = 





88001
€ 114,95

88002
€ 124,95

88003
€ 259,50





88004
€ 229,95

88005
€ 209,95



88006
€ 119,50

88007
€ 109,95



88008
€ 189,95



88009
€ 44,95



88010
€ 139,95

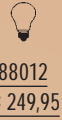

88011
€ 57,95



88012
€ 249,95



88013
€ 139,95



88014
€ 129,95

88010 Stahl, Glas satiniert, mit Tastdimmer, H. 197 cm, inkl. LM 300 W, R7s, 118 mm, HV

88011 Stahl, Glas satiniert, mit Drehdimmer, H. 34 cm, B. 26 cm, Ausl. 11 cm, inkl. LM 100 W, R7s, 78 mm, HV

88012 Chrom, Glas weiß, Ø 32 cm, H. 156 cm, LM 100 W, E27

88013 Chrom, Glas weiß, H. max. 200 cm, L. 32 cm, B. 32 cm, LM 75 W, E27

88014 Chrom, Glas weiß, Ø 27 cm, H. 52 cm, LM 60 W, E27

88015 Stahl, mit Touch-Dimmer, höhenverstellbar 91-130 cm, inkl. LM 40 W, G9, HV

88016 Stahl, mit Touch-Dimmer, H. 12 cm, Ausl. 46,5 cm, inkl. LM 40 W, G9, HV

88017 Stahl, mit Touch-Dimmer, H. 37 cm, inkl. LM 40 W, G9, HV

88018 Nickel matt, Schirm weiß, Ø 45 cm, Schirm-H. 32 cm, LM 100 W, E27, geeignet für 20 W Sparlampe

88019 Nickel matt, Schirm weiß, H. 52 cm, Ø 27 cm, Schirm-H. 23 cm, LM 60 W, E27, geeignet für 15 W Sparlampe

88020 Nickel matt, Schirm weiß, H. 151 cm, Ø 45 cm, Schirm-H. 32 cm, LM 100 W, E27, geeignet für 20 W Sparlampe

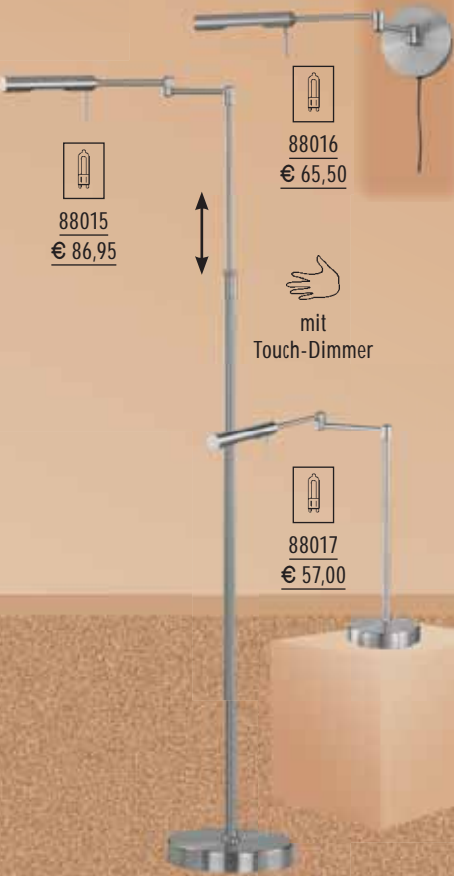

88015
€ 86,95

88016
€ 65,50

mit Touch-Dimmer

88017
€ 57,00

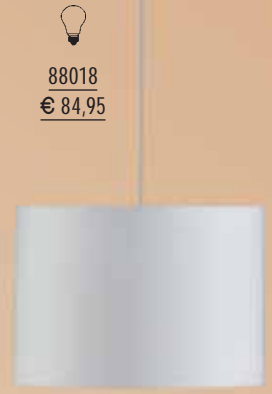

88018
€ 84,95



88019
€ 54,95



88020
€ 156,95

LEUCHTENSERIEN

88021 Messing matt,
Glas opal matt, höhenverstellbar
von 83-127 cm, B. 90 cm,
inkl. LM 5x35 W, GY6,35, NV

88022 Messing matt,
Glas opal matt, mit Tastdimmer,
H. 29,5 cm, Ausl. 31 cm,
inkl. Osram LM 60 W, G9, HV

88023 Messing matt,
Glas opal matt, mit Tastdimmer,
H. 29 cm, Ø 14 cm,
inkl. Osram LM 60 W, G9, HV

88024 Messing matt,
Glas opal matt, mit Tastdimmer,
H. 180 cm, inkl. Osram LM 2x75 W,
G9, HV

88025 Nickel matt, Glas opal matt,
Ø 37 cm, H. 29 cm, LM 3x60 W,
E27

88026 Nickel matt, Glas opal matt,
mit Touch-Dimmer, Ø 30 cm,
H. 38 cm, LM 2x40 W, E14

88027 Nickel matt, Glas opal matt,
mit Zugschalter, Ø 37 cm, H. 140 cm,
LM 3x60 W, E27

88028 Messing matt/polirt,
Schirm champagner, mit Schalter,
H. 30 cm, Ø 23 cm, Ausl. bis 38 cm,
LM 60 W, E27

88029 Messing matt/polirt,
Schirm champagner, H. 41 cm,
Ø 26 cm, LM 60 W, E27

88030 Messing matt/polirt,
Schirm champagner, mit Schalter,
H. 156 cm, Ø 42 cm, LM 100 W, E27



88021
€ 229,95



88022
€ 99,95



88023
€ 84,95



88024
€ 249,95



88025
€ 72,95



88026
€ 44,00



mit
Touch-Dimmer



88027
€ 119,95



88028
€ 59,95



88029
€ 69,00



88030
€ 139,95

88031
€ 198,95



88032
€ 138,95

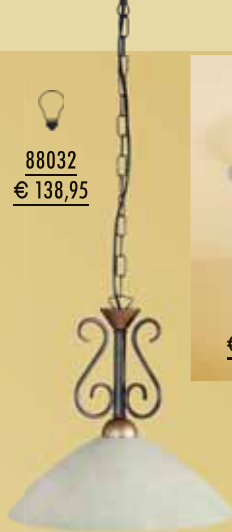

88033
€ 158,95



88034
€ 122,95



88031 Antik-braun/altgold abgesetzt, Glas Scavo champagner, Glas-Ø 28 cm, H. 120 cm, B. 75 cm, LM 2x100 W, E27

88032 Antik-braun/altgold abgesetzt, Glas Scavo champagner, Glas-Ø 38 cm, H. 120 cm, LM 100 W, E27

88033 Antik-braun/altgold abgesetzt, Glas Scavo champagner, H. 20 cm, Ø 46 cm, LM 4x40 W, E14

88034 Antik-braun/altgold abgesetzt, Glas Scavo champagner, H. 50 cm, Ausl. 20 cm, LM 60 W, E27

88035 Rostfarbig, Glas Scavo, Ø 90 cm, H. 12 cm, inkl. LM 6x40 W, G9, HV

88036 Rostfarbig antik, Glas ätzmatt weiß mit Dekor, Ø 44 cm, H. 22 cm, 3x60 W, E27

88037 Rostfarbig/gold antik lackiert, Glas alabasterfarbig, mit Drehdimmer, H. 120 cm, Ø 55 cm, LM 5x40 W, E14

88038 Rostfarbig, Glas Scavo, mit Schalter, H. 62 cm, inkl. LM 60 W, G9, HV

88039 Rostfarbig antik, Glas alabasterfarbig weiß, Glas-Ø 33 cm, B. 79 cm, LM 2x60 W, E27

88040 Rostfarbig antik, Glas alabasterfarbig weiß, Ø 45 cm, LM 100 W, E27

88041 Rostfarbig antik, Glas alabasterfarbig weiß, B. 33 cm, H. 28 cm, Ausl. 19 cm, LM 60 W, E27

88042 Rostfarbig antik, Glas alabasterfarbig weiß, Glas-Ø 19 cm, H. 32cm, LM 40 W, E14

88035
€ 219,95

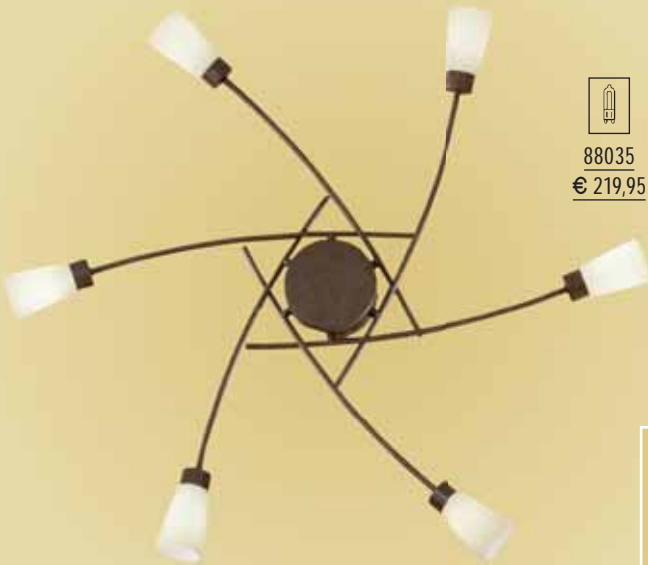

88036
€ 99,95



88037
€ 92,95



Drehdimmer

88038
€ 59,50

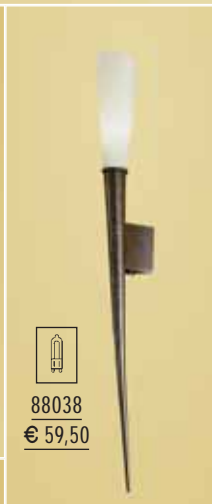

88039
€ 94,95



88040
€ 72,50



88041
€ 65,00



88042
€ 45,50



WAND-/DECKENLEUCHTEN

88043 Messing matt, Spotglas opal matt, Glasscheibe teilsatiniert, L. 112 cm, Ø 23 cm, inkl. LM 4x40 W und 4x25 W, G9, HV



88043
€ 99,95

88044 Stahl, Spotglas opal matt, Glasscheibe teilsatiniert, L. 112 cm, Ø 23 cm, inkl. LM 4x40 W und 4x25 W, G9, HV



88044
€ 99,95

88045 Messing matt, Glas champagner, Ø 43 cm, LM 3x60 W, E27, geeignet für 11 W Sparlampe

88046 Rostfarbig antik, Glas champagner gewischt, mit terrakotta Dekor, Ø 30 cm, LM 60 W, E27

88047 Rostfarbig antik, Glas champagner gewischt, mit terrakotta Dekor, Ø 40 cm, LM 2x60 W, E27

88048 Rostfarbig antik, Glas champagner gewischt, mit terrakotta Dekor, B. 30 cm, Ausl. 9 cm, LM 60 W, E27

88049 Altmessing, Glas alabasterfarbig, Ø 30 cm, LM 60 W, E27

88050 Altmessing, Glas alabasterfarbig, Ø 40 cm, LM 2x60 W, E27

88051 Gold matt, Glas opal weiß, H. 10 cm, Ø 25 cm, LM 60 W, E27

88052 Gold matt, Glas opal weiß, H. 10 cm, Ø 30 cm, LM 2x60 W, E27

88053 Messing matt, Schutenglas weiß, mit Schalter, H. 30 cm, B. 8,5 cm, Ausl. 11 cm, inkl. LM 40 W, G9, HV

88054 Stahl, Schutenglas weiß, mit Schalter, H. 30 cm, B. 8,5 cm, Ausl. 11 cm, inkl. LM 40 W, G9, HV

88055 Altmessing, Glas alabasterfarbig, B. 30 cm, Ausl. 15 cm, LM 60 W, E27

88056 Gold matt, Glas opal weiß, B. 27,5 cm, Ausl. 14,5 cm, LM 60 W, E27

88057 Messing matt, Glas opal matt, H. 38 cm, B. 17 cm, Ausl. 9 cm, LM 40 W, E14

88058 Messing matt, mit Kippschalter, B. 44 cm, Ausl. 22,5 cm, inkl. LM 8 W, T5

88059 Stahl gebürstet, mit Kippschalter, B. 44 cm, Ausl. 22,5 cm, inkl. LM 8 W, T5

88060 Nickel matt, Glas opal matt, H. 38 cm, B. 17 cm, Ausl. 9 cm, LM 40 W, E14



88045
€ 59,95



Ø 30 cm
88046
€ 24,95



Ø 40 cm
88047
€ 39,95



Ø 30 cm
88049
€ 24,95



Ø 40 cm
88050
€ 39,95



messing matt
88053
€ 56,00



stahl
88054
€ 56,00



88055
€ 24,95



88056
€ 29,95



88057
€ 37,95



88058
€ 82,95

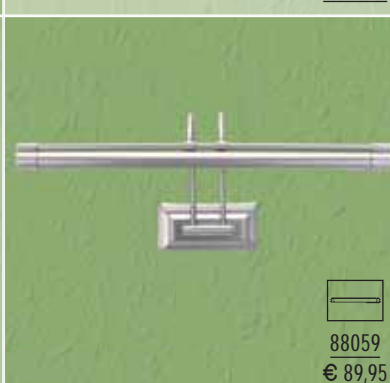

88059
€ 89,95



88060
€ 37,95



88061
€ 51,95



88062
€ 32,50



88063
€ 39,95



88064
€ 45,00



88065
€ 109,50



Ø 30 cm
88066
€ 46,95

Ø 36 cm
88067
€ 58,95

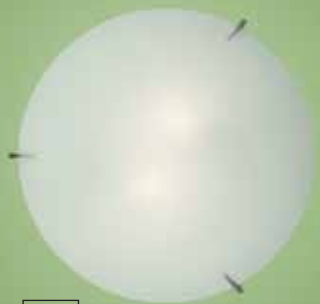

88068
€ 43,95



Ø 30 cm
88069
€ 28,95

Ø 40 cm
88070
€ 42,95



88071
€ 25,95



Ø 32 cm
88072
€ 41,95

Ø 40 cm
88073
€ 54,95



Ø 30 cm
88074
€ 24,95

Ø 40 cm
88075
€ 39,95



Ø 25 cm
88076
€ 25,95

Ø 30 cm
88077
€ 39,95



88078
€ 35,95



88079
€ 19,95



88080
€ 29,95

88061 1 glänzend satiniertes und 2 satinierte weiße Gläser, H. 27 cm, B. 19 cm, LM 60 W, E27

88062 Glas weiß satiniert, H. 19 cm, B. 18 cm, Ausl. 8 cm, LM 40 W, E14

88063 Wandleuchte, Nickel matt, Glas alabasterfarbig weiß, H. 40 cm, B. 20 cm, LM 2x40 W, E14

88064 Nickel matt, Glas opal matt, mit Zugschalter, Ausl. 48 cm, inkl. LM 40 W, G9, HV

88065 Halterung Kunststoff weiß, Abdeckung Glas opal seidenmatt, mit Präsenzmelder, Reichweite ca. 1-8 m im Durchmesser, verstellbar, Erfassungsbereich 360°, Zeitregelung ca. 5 Sec.-15 Min., Ø 37 cm, H. 11,8 cm, Deckenmontage IP43, Wandmontage IP44, LM 60 W, E27

88066 Glas opal weiß, Bajonettverschluss, mit indirekt orangefarbigem Rand, Ø 30 cm, LM 100 W, E27

88067 Glas opal weiß, Bajonettverschluss, mit indirekt orangefarbigem Rand, Ø 36 cm, LM 2x60 W, E27

88068 Nickel matt, Glas ätzmatt, Ø 40 cm, inkl. LM 150 W, R7s, 118 mm, HV

88069 Nickel matt, Glas satiniert, Ø 30 cm, LM 60 W, E27

88070 Nickel matt, Glas satiniert, Ø 40 cm, LM 2x60 W, E27

88071 Nickel matt, Glas satiniert, B. 30 cm, LM 60 W, E27

88072 Buchefarbig/Nickel matt, Glas seidenmatt, Ø 32 cm, LM 75 W, E27

88073 Buchefarbig/Nickel matt, Glas seidenmatt, Ø 40 cm, LM 2x40 W, E27

88074 Stahl, Glas alabasterfarbig, Ø 30 cm, LM 60 W, E27

88075 Stahl, Glas alabasterfarbig, Ø 40 cm, LM 2x60 W, E27

88076 Nickel matt, Glas opal weiß, Ø 25 cm, H. 10 cm, LM 60 W, E27

88077 Nickel matt, Glas opal weiß, Ø 30 cm, H. 10 cm, LM 2x60 W, E27

88078 Buchefarbig/Nickel matt, Glas seidenmatt, B. 32 cm, H. 16,5 cm, LM 60 W, E27

88079 Stahl, Glas alabasterfarbig, B. 30 cm, H. 15 cm, Ausl. 8 cm, LM 60 W, E27

88080 Nickel matt, Glas opal weiß, B. 27,5 cm, H. 14,5 cm, LM 60 W, E27

WAND-/DECKENLEUCHTEN

88081 Chrom, Ø 100 cm, H. 36 cm, inkl. klarem Osram LM 20x10 W, G4, NV



88081
€ 399,95



88082
€ 139,00

88082 Chrom, Glaskugeln klar, Ø 35 cm, H. 40 cm, inkl. Osram LM 5x20 W, GU5,3, NV

88083 Nickel matt, Glas klar/weiß matt, L. 53 cm, B. 26 cm, H. 30 cm, inkl. LM 150 W, R7s, 78 mm, HV



88083
€ 189,95



88084
€ 179,95

88084 Chrom, Ø 58 cm, H. 20 cm, inkl. LM 20x10 W, G4, NV

88085 Chrom, Glas satiniert/klar, Ø 100 cm, H. 16 cm, inkl. LM 21x10 W, G4, NV

88086 Chrom, Glas satiniert, L. 52 cm, B. 35 cm, H. 12 cm, inkl. LM 150 W, R7s, 118 mm, HV



88085
€ 198,00



88086
€ 158,00

88087 Stahl, inkl. integriertem Serienschalter, dadurch lassen sich der LED-Sternenhimmel, die Downlights oder beides gleichzeitig schalten, Downlights schwenkbar, Ø 75 cm, H. 6 cm, IP20, inkl. LM 5x20 W, GU5,3, NV und 120x0,06 W, LED, warmweiß



88087
€ 299,95



88088
€ 109,95



88089
€ 98,95

88088 Nickel gebürstet, Gläser weiß satiniert, L. 46 cm, H. 9 cm, Ausl. 8 cm, inkl. LM 150 W, R7s, 118 mm, HV

88089 Nickel gebürstet, Gläser weiß satiniert, L. 39 cm, H. 9 cm, Ausl. 7 cm, inkl. LM 150 W, R7s, 118 mm, HV



88090
€ 105,95



88091
€ 59,95



88090 Nickel satiniert, Glas opal weiß, Ø 60 cm, inkl. LM 3x50 W, GU10 und 2x40 W, G9, HV

88091 Nickel matt, Glas opal matt, Ø 50 cm, inkl. LM 3x40 W, G9, HV

88092 Verchromt, glänzend satiniertes Glas, Ø 37 cm, H. 12 cm, inkl. LM 6x40 W, G9, HV



88092
€ 159,95



88093
€ 72,95



88094
€ 42,00

88093 Chrom, Glas satiniert, B. 32 cm, H. 8 cm, Ausl. 18 cm, inkl. LM 150 W, R7s, 78 mm, HV

88094 Nickel matt, Glas opal matt, H. 20 cm, B. 20 cm, Ausl. 15 cm, inkl. LM 100 W, R7s, 78 mm, HV

88095 Nickel matt, Glas amberfarbig, H. 24 cm, Ø 11 cm, inkl. LM 60 W, G9, HV



Glas amber
88095
€ 69,95



Glas weiß
88096
€ 69,95



88097
€ 88,50



88098
€ 69,95

88096 Nickel matt, Glas opal weiß, H. 24 cm, Ø 11 cm, inkl. LM 60 W, G9, HV

88097 Metall, titan-silber, H. 21 cm, B. 6 cm, Ausl. 9 cm, LM MEGAMAN 2x11 W, GU10, HV

88098 Verchromt, Glas weiß gestreift, H. 23 cm, Ø 20 cm, Ausl. 26 cm, LM 60 W, E14



88101
€ 59,50



88099
€ 49,95



Glas weiß
88103
€ 53,95



Glas amber
88102
€ 53,95



88100
€ 49,95

88099 Glas weiß satiniert, L. 30 cm, B. 30 cm, LM 2x75 W, E27

88100 Glas amberfarbig, L. 30 cm, B. 30 cm, LM 2x75 W, E27

88101 Nickel satiniert, Glas opal weiß, mit Schalter, H. 62 cm, inkl. LM 60 W, G9, HV

88102 Nickel satiniert, Glas amberfarbig, L. 36 cm, B. 11 cm, Ausl. 11 cm, LM 75 W, E27

88103 Nickel satiniert, Glas weiß, L. 36 cm, B. 11 cm, Ausl. 11 cm, LM 75 W, E27

PENDELLEUCHTEN

88104 Stahl, Glas opal,
mit Touchdimmer,
höhenverstellbar v. 82-142 cm,
B. 58 cm, inkl. Osram LM 3x35 W,
GY6,35, NV

88105 Stahl, Glas opal,
mit Touchdimmer,
höhenverstellbar v. 82-142 cm,
Ø 30 cm, inkl. Osram LM 3x35 W,
GY6,35, NV

88106 Stahl, Glas opal matt,
mit Touchdimmer,
höhenverstellbar v. 83-128 cm,
B. 146 cm, inkl. Osram LM 5x20 W,
G4, NV

88107 Stahl, Glas opal matt,
mit Touchdimmer,
höhenverstellbar v. 87-128 cm,
B. 80 cm, inkl. Osram LM 3x35 W,
GY6,35, NV

88108 Nickel matt,
Glas alabasterfarbig,
höhenverstellbar, B. 60 cm,
inkl. LM 4x20 W, G4, NV

88109 Stahl, Glas alabasterfarbig
mit Decor, oval, mit Touchdimmer,
höhenverstellbar v. 84-127 cm,
B. 80 cm, inkl. LM 5x20 W, G4, NV

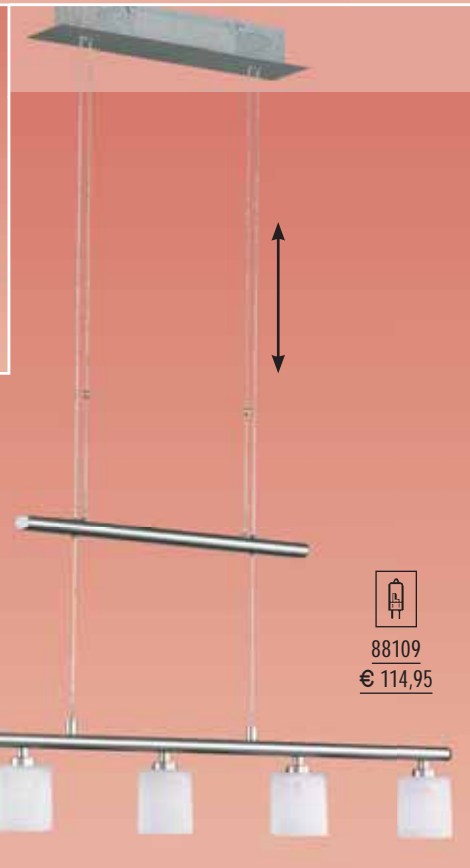
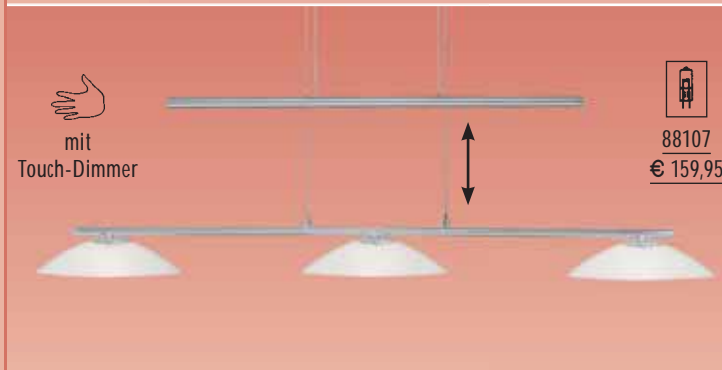
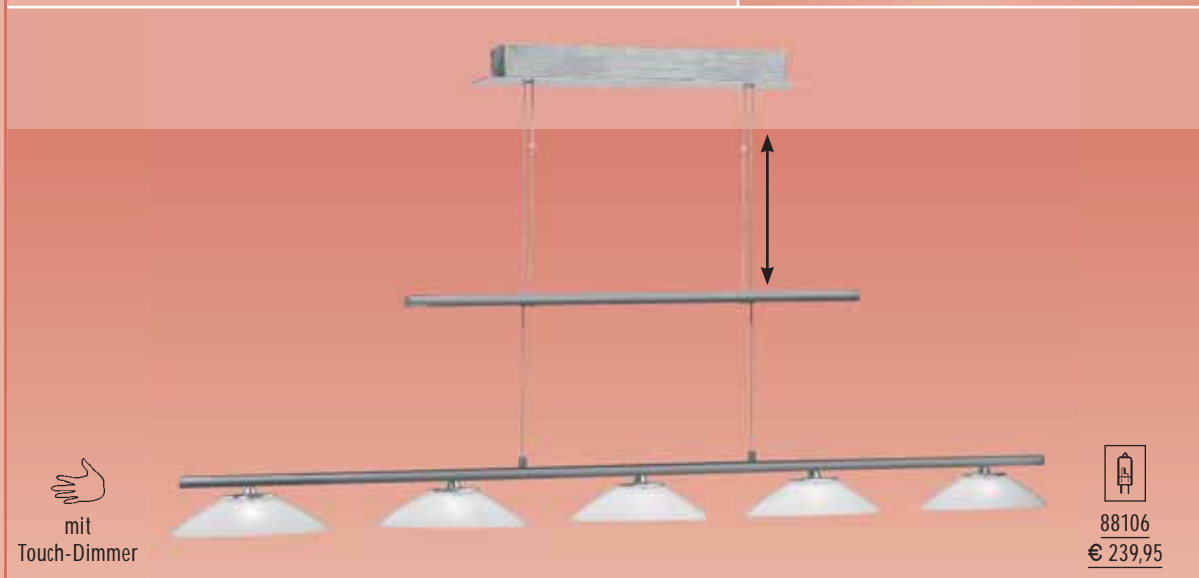
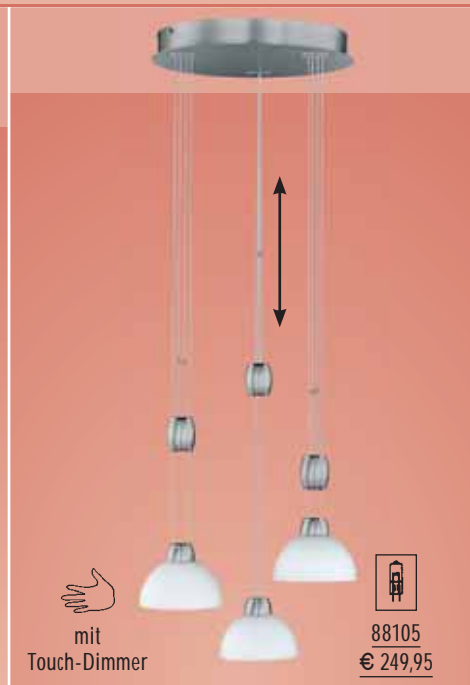

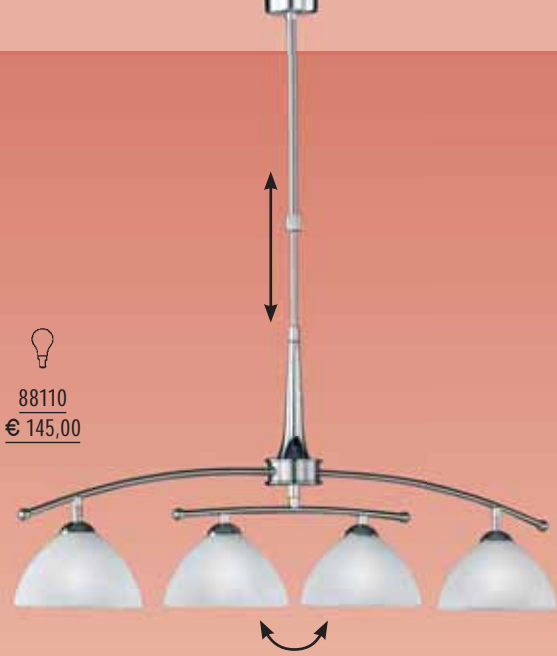

88110
€ 145,00



88111
€ 169,50

88110 Nickel matt/chrom, Glas alabasterfarbig weiß, Glas-Ø 18 cm, höhenverstellbar v. 85-120 cm, Innenteil verstellbar, B. 38 cm, B. 85 cm, LM 4x40 W, E14

88111 Titan-silber, Glas satiniert, höhenverstellbar von 65-135 cm, Ø 46 cm, LM 100 W, E27

88112 Stahl, Glas opal matt, höhenverstellbar v. 84-127 cm, mit Touchdimmer, B. 91 cm, inkl. LM 5x20 W, G4, NV

88113 Metall, titan-silber, Ø 19 cm, H. 23 cm, Gesamt-H. 150 cm, LM 60 W, E27

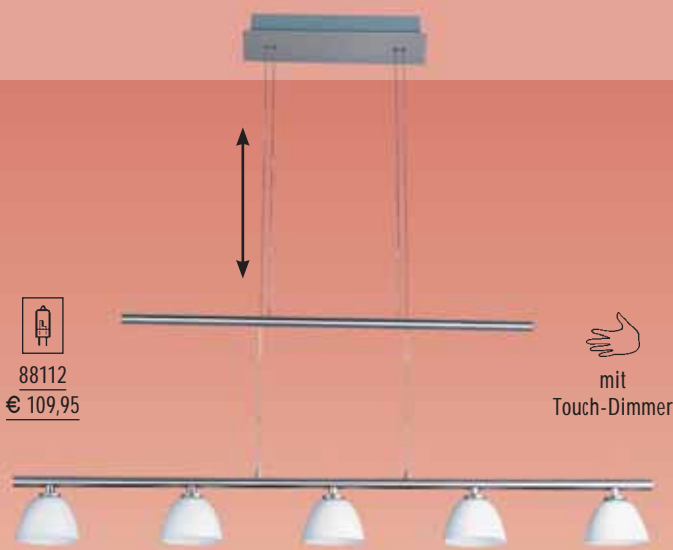

88112
€ 109,95

mit
Touch-Dimmer



88113
€ 45,50

88114 Titan/Buche, Glas alabasterfarbig, höhenverstellbar v. 70-150 cm, Ø 45 cm, LM 100 W, E27

88115 Weiß, Ø 48 cm, H. 60 cm, LM 40 W, G10q, ringförmige Leuchtstofflampe



88114
€ 109,95



88115
€ 89,50

88116 Glas weiß/klar, mit Zugpendel, Ø 40 cm, LM 100 W, E27

88117 Aluminiumfarbig, Glas opal seidenmatt, Ø 30 cm, LM 100 W, E27



88116
€ 39,95



Ø 30 cm
88117
€ 45,95

Ø 35 cm
88118
€ 68,95



88119
€ 43,95

88118 Aluminiumfarbig, Glas opal seidenmatt, Ø 35 cm, LM 100 W, E27

88119 Aluminiumfarbig, Opalglas matt, Ø 10 cm, LM 40 W, E14

PENDELLEUCHTEN

88120 Messing matt/polirt,
Glas alabasterfarbig weiß,
Glas-Ø 18 cm, höhenverstellbar
v. 85-120 cm, Innenteil verstellbar,
B. 38 cm, B. 85 cm, LM 4x40 W, E14

88121 Altmessing gefärbt,
Glas Scavo-Sahara, Kabellift gold,
höhenverstellbar v. 70-130 cm,
Ø 42 cm, LM 100 W, E27

88122 Altmessing,
Glas alabasterfarbig weiß,
Glas-Ø 18 cm, höhenverstellbar
v. 85-120 cm, Innenteil verstellbar,
B. 38 cm, B. 85 cm, LM 4x40 W, E14

88123 Altmessing,
Glas alabasterfarbig weiß,
höhenverstellbar, Glas-Ø 39 cm,
100 W, E27

88124 Altmessing,
Glas alabasterfarbig weiß,
höhenverstellbar, seitlich ausziehbar
B. 75-115 cm, Glas-Ø 30 cm,
2x60 W, E27

88125 Altmessing,
Glas alabasterfarbig weiß, Ø 67 cm,
Glas-Ø 21 cm, LM 5x60 W, E27



Lightbulb icon
88120
€ 145,00

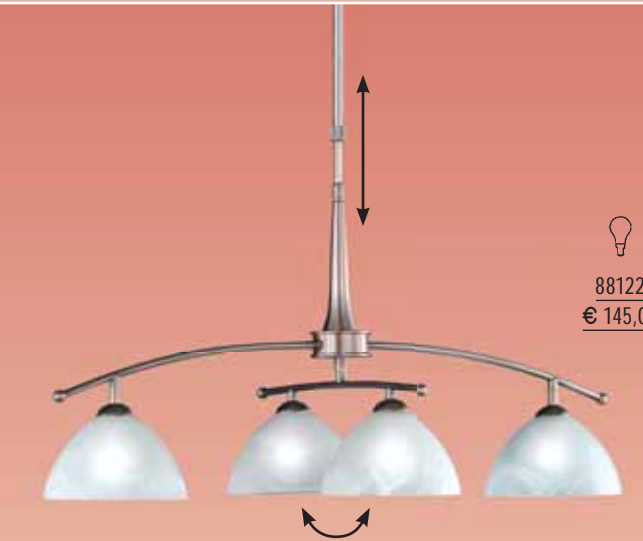

Lightbulb icon
88122
€ 145,00



Lightbulb icon
88124
€ 174,95

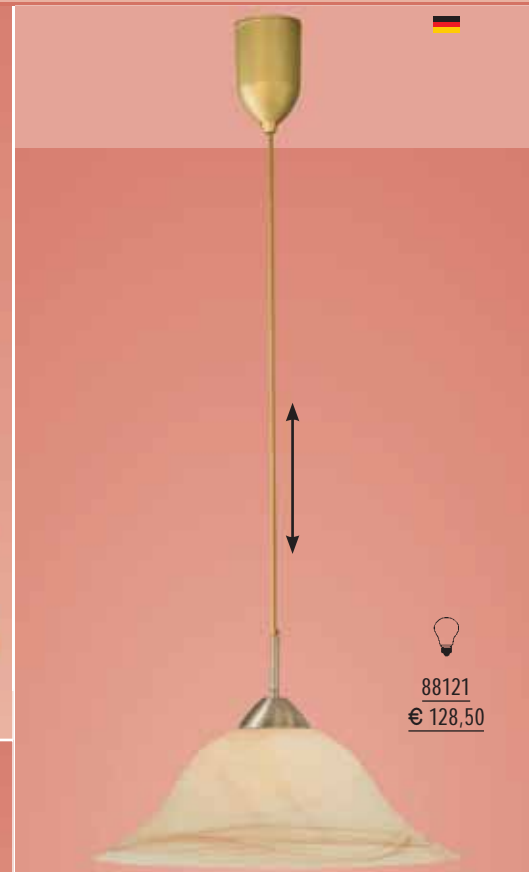

Lightbulb icon
88121
€ 128,50



Lightbulb icon
88123
€ 149,95



Lightbulb icon
88125
€ 159,95

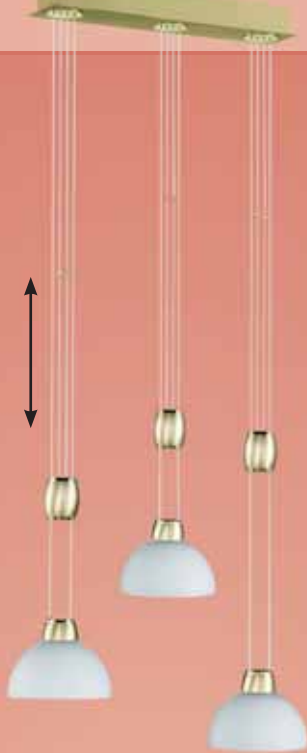

88126
€ 249,95



mit
Touch-Dimmer

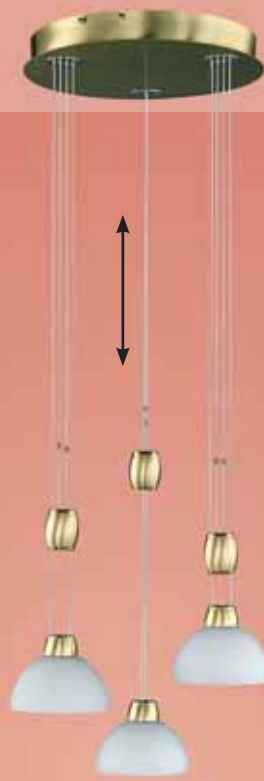

88127
€ 249,95



mit
Touch-Dimmer

88126 Messing matt, Glas opal, mit Touchdimmer, höhenverstellbar v. 82-142 cm, B. 58 cm, inkl. Osram LM 3x35 W, GY6,35, NV

88127 Messing matt, Glas opal, mit Touchdimmer, höhenverstellbar v. 82-142 cm, B. 30 cm, inkl. Osram LM 3x35 W, GY6,35, NV

88128 Altmessing, Glas alabasterfarbig mit Decor, oval, mit Touchdimmer, höhenverstellbar v. 84-127 cm, B. 80 cm, inkl. LM 5x20 W, G4, NV

88129 Weiß mit klarem Behang, Ø 54 cm, H. 50 cm, LM 5x40 W, E14

88130 Messing matt, Glas weiß satiniert, mit Kabellift, höhenverstellbar von 70-130 cm, Ø 39 cm, LM 100 W, E27

88131 Messing matt, Glas weiß satiniert, Ø 20 cm, H. 120 cm, LM 75 W, E27

88132 Messing matt, Glas alabasterfarbig, höhenverstellbar v. 70-150 cm, Ø 40 cm, LM 100 W, E27

88133 Nickel matt, Glas weiß satiniert, mit Kabellift, höhenverstellbar von 70-130 cm, Ø 39 cm, LM 100 W, E27

88134 Nickel matt, Glas weiß satiniert, Ø 20 cm, H. 120 cm, LM 75 W, E27

88135 Nickel matt, Glas alabasterfarbig, höhenverstellbar v. 70-150 cm, Ø 40 cm, LM 100 W, E27

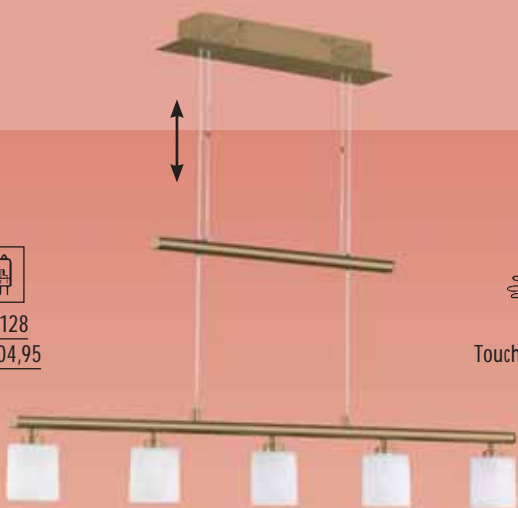

88128
€ 104,95



mit
Touch-Dimmer



88129
€ 149,95

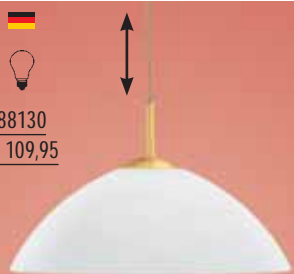

88130
€ 109,95



88131
€ 69,95



88132
€ 77,95



88133
€ 109,95



88134
€ 79,95



88135
€ 81,95

STEHLEUCHTEN

88136 Nickel matt, Glas alabasterfarbig, Fluter dimmbar, Lesearm mit Ein-Ausschalter, H. 180 cm, inkl. LM 55 W, TC-DD, GR10q und 7 W, GU10

88137 Nickel matt, Glas opal weiß, mit Fußschalter, H. 180 cm, inkl. LM 55 W, TC-DD, GR10q

88138 Stahl, mit höhenverstellbarem Lesearm und zwei Tastdimmern, H. 180 cm, inkl. LM 150 W, 78 mm und 300 W, 118 mm, R7s, HV

88139 Messing matt, mit höhenverstellbarem Lesearm und zwei Tastdimmern, H. 180 cm, inkl. LM 150 W, 78 mm und 300 W, 118 mm, R7s, HV

88140 Chrom, Kunststoffschirm weiß, Marmorfuß Ø 38 cm, Schirm Ø 40 cm, mit Fußschalter, höhenverstellbar 190-215 cm, LM 75 W, E27

88141 Nickel matt, Glas satiniert, oval, mit Sensordimmer, H. 180 cm, B. 48 cm, inkl. LM 300 W, R7s, 118 mm, HV

88142 Stahl, Glas alabasterfarbig, mit Lesearm, zweifach dimmbar, H. 184 cm, Ø 35 cm, inkl. LM 300 W, R7s, 118 mm, HV und 50 W, GY6,35, NV

88143 Altmessing, Glas alabasterfarbig, mit Lesearm, zweifach dimmbar, H. 184 cm, Ø 35 cm, inkl. LM 300 W, R7s, 118 mm, HV und 50 W, GY6,35, NV



88136
€ 239,95

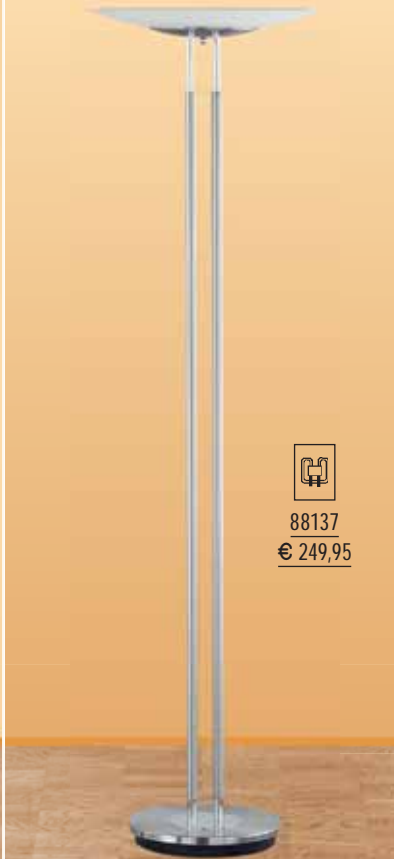

88137
€ 249,95



stahl
88138
€ 229,95

messing matt
88139
€ 229,95



88140
€ 179,95

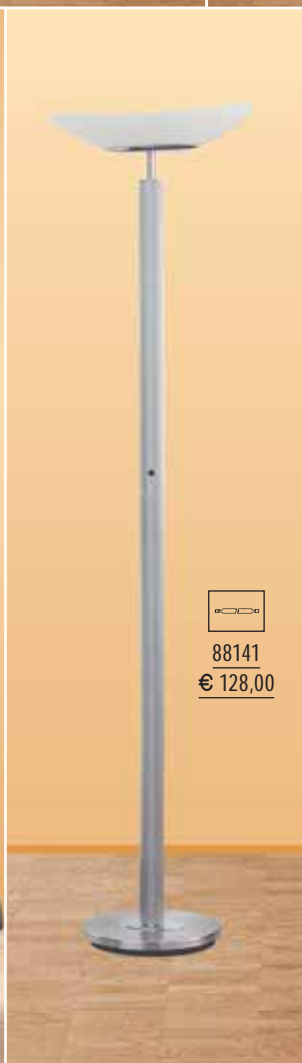

88141
€ 128,00



stahl
88142
€ 174,95

altmessing
88143
€ 174,95



stahl
88144
€ 99,95

messing matt
88145
€ 99,95

altmessing
88146
€ 99,95



Glas orange,
gelb, weiß
88147
€ 59,95

Glas weiß
88148
€ 59,95



nickel matt
88149
€ 69,95

messing matt
88150
€ 69,95

altmessing
88151
€ 69,95

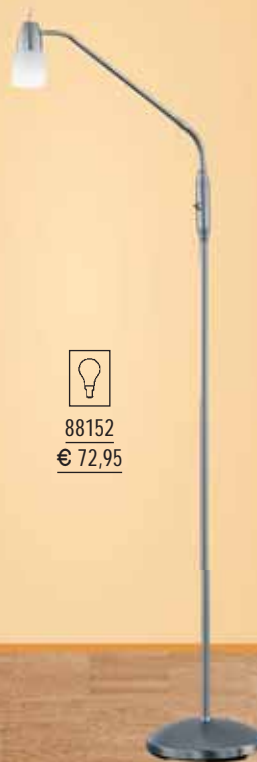

88152
€ 72,95

88144 Stahl, Glas satiniert, mit Lesearm, zweifach dimmbar, H. 180 cm, inkl. Osram LM 300 W, R7s, 118 mm und 40 W, G9, HV

88145 Messing matt, Glas satiniert, mit Lesearm, zweifach dimmbar, H. 180 cm, inkl. Osram LM 300 W, R7s, 118 mm und 40 W, G9, HV

88146 Altmessing, Glas satiniert, mit Lesearm, zweifach dimmbar, H. 180 cm, inkl. Osram LM 300 W, R7s, 118 mm und 40 W, G9, HV

88147 Nickel matt, Glas orange, gelb, weiß, mit Lesearm, schalt- und dimmbar, H. 180 cm, LM 200 W, E27 und inkl. 50 W, GZ10, HV

88148 Nickel matt, Glas weiß, mit Lesearm, schalt- und dimmbar, H. 180 cm, LM 200 W, E27 und inkl. 50 W, GZ10, HV

88149 Nickel matt, 2-Stufen schaltbar, 35/50 W umschaltbar, H. 140 cm, inkl. LM 50 W, GY6,35, NV

88150 Messing matt, 2-Stufen schaltbar, 35/50 W umschaltbar, H. 140 cm, inkl. LM 50 W, GY6,35, NV

88151 Altmessing, 2-Stufen schaltbar, 35/50 W umschaltbar, H. 140 cm, inkl. LM 50 W, GY6,35, NV

88152 Stahl, Glas opal matt, mit Kippschalter, Arm flexibel, H. 157 cm, inkl. LM 7 W, E14

88153 Rattan, mit innenliegendem cremefarbigem Stoffschirm, mit Fußschalter, Ø 25 cm, H. 120 cm, LM 2x40 W, E27

88154 Organzaschirm weiß, mit Fußschalter, H. 140 cm, Ø 26 cm, LM 3x40 W, E14

88155 Nickel matt, Glas weiß verstellbar, höhenverstellbar von 105-140 cm, LM 100 W, E27

88156 Messing matt, Glas weiß verstellbar, höhenverstellbar von 105-140 cm, LM 100 W, E27

88153
€ 120,00



88154
€ 149,95

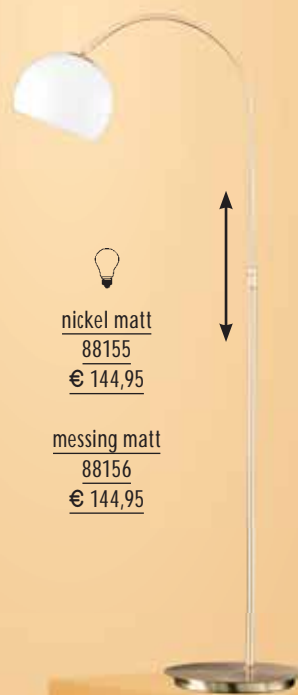

nickel matt
88155
€ 144,95

messing matt
88156
€ 144,95

TISCHLEUCHTEN

88157 Glas weiß,
mit Touch-Dimmer, H. 25 cm,
Ø 13 cm, LM 60 W, E14





88157
€ 87,95

mit
Touch-Dimmer

88158 Glas amber,
mit Touch-Dimmer, H. 25 cm,
Ø 13 cm, LM 60 W, E14



88158
€ 99,95

mit
Touch-Dimmer

88159 Nickel satiniert,
Glas opal weiß, mit Touch-Dimmer,
H. 13 cm, Ø 15 cm, inkl. LM 40 W,
G9, HV





88159
€ 37,95

mit
Touch-Dimmer

88160 Nickel satiniert,
Glas opal weiß, mit Touch-Dimmer,
H. 25 cm, inkl. LM 40 W, G9, HV





88160
€ 36,95

mit
Touch-Dimmer

88162 Messing satiniert,
Glas amber, mit Touch-Dimmer,
H. 13 cm, Ø 15 cm, inkl. LM 40 W,
G9, HV



88162
€ 36,95

mit
Touch-Dimmer

88163 Nickel satiniert,
Glas opal weiß, mit Touch-Dimmer,
H. 25 cm, Ø 15 cm, inkl. LM 40 W,
G9, HV



88163
€ 37,95

mit
Touch-Dimmer

88164 Messing satiniert,
Glas amber, mit Touch-Dimmer,
H. 25 cm, Ø 15 cm, inkl. LM 40 W,
G9, HV



88164
€ 37,95



mit
Touch-Dimmer

88164
€ 37,95

mit
Touch-Dimmer

88165 Nickel matt,
Glas cremefarbig gewischt,
Ein-Ausschalter, H. 20 cm, Ø 9,5 cm,
inkl. LM 7 W, E14





88165
€ 23,50

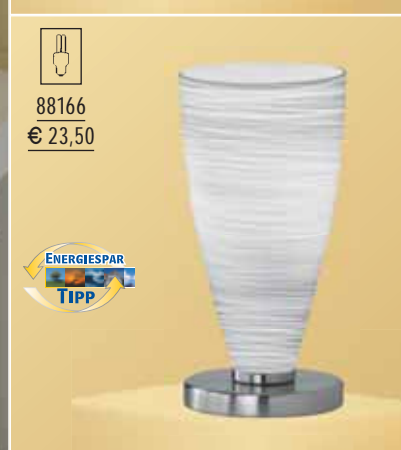

88166 Nickel matt,
Glas opal matt gewischt,
Ein-Ausschalter, H. 20 cm, Ø 9,5 cm,
inkl. LM 7 W, E14



88166
€ 23,50





88167
€ 39,95



mit
Touch-Dimmer



88168
€ 39,95



mit
Touch-Dimmer



88169
€ 46,95



88167 Messing matt, Glas opal, mit Touch-Dimmer, H. 38 cm, Ø 28 cm, inkl. Osram LM 40 W, G9, HV

88168 Stahl, Glas opal, mit Touch-Dimmer, H. 38 cm, Ø 28 cm, inkl. Osram LM 40 W, G9, HV

88169 Stahl, Glas opal matt, mit Kippschalter, Arm flexibel, H. max. 40 cm, inkl. LM 7 W, E14



88170
€ 57,95



88171
€ 57,95



88172
€ 37,95



88170 Nickel matt, mit Dimmer, H. max. 55 cm, Ausl. 50 cm, inkl. LM 100 W, R7s, 78 mm, HV

88171 Messing matt, mit Dimmer, H. max. 55 cm, Ausl. 50 cm, inkl. LM 100 W, R7s, 78 mm, HV

88172 Aluminium/chrom, mit Schalter und flexiblem Arm, H. bis 49 cm, LM 40 W, E14, R50

88173 Altmessing, mit Schalter, H. bis 75 cm verstellbar, inkl. Osram LM 40 W, G9, HV



88173
€ 81,95



88174
€ 36,95



mit
Touch-Dimmer



88175
€ 59,95



88174 Stahl, mit Touchdimmer, H. max. 50 cm, Arm flexibel, inkl. LM 40 W, G9, HV

88175 Aluminium/chrom, mit Klemmfuß, Schalter und flexiblem Arm, H. bis 100 cm, LM 60 W, E27

88176 Nickel matt, mit Schalter, H. bis 75 cm verstellbar, inkl. Osram LM 40 W, G9, HV



88176
€ 75,00



Ø 30 cm
88178
€ 42,95



Ø 20 cm
88177
€ 24,95



Ø 25 cm
88179
€ 32,95

88177 Glas opal seidenmatt, mit Schnurzwischenschalter, Ø 20 cm, LM 60 W, E27

88178 Glas opal seidenmatt, mit Schnurzwischenschalter, Ø 30 cm, LM 60 W, E27

88179 Glas opal seidenmatt, mit Schnurzwischenschalter, Ø 25 cm, LM 60 W, E27

TISCHLEUCHTEN

88180 Schwarz, mit Sockel und Klemmvorrichtung, H. 75 cm, inkl. Osram LM 11 W, G23

88181 Weiß, mit Sockel und Klemmvorrichtung, H. 75 cm, inkl. Osram LM 11 W, G23

88182 Titan, mit Sockel und Klemmvorrichtung, H. 75 cm, inkl. Osram LM 11 W, G23

88183 Schwarz/chrom matt, H. 65 cm, Ausl. 80 cm, inkl. LM 11 W, G23

88184 Blau, H. max. 46 cm, ausziehbar, Fuß Ø 8,5 cm, inkl. LM 20 W, G4, NV

88185 Silber, H. max. 46 cm, ausziehbar, Fuß Ø 8,5 cm, inkl. LM 20 W, G4, NV

88186 Titan/schwarz, H. max. 62 cm, inkl. LM 50 W, GY6,35, NV

88187 Stahl, Glas alabasterfarbig, mit Schalter und flexiblem Arm, H. bis 40 cm, inkl. Osram LM 25 W, G9, HV

88188 Stahl, Glas alabasterfarbig, mit flexiblem Arm, Kippschalter, Ø 5 cm, Ausl. 15 cm, inkl. LM 40 W, G9, HV

88189 Stahl, mit flexiblem Arm und integriertem Schutzkontaktstecker, Schalter, H. 31,5 cm, inkl. Philips LM 50 W, GU10, HV

88190 Titan, mit Schalter, Arm flexibel, H. 32 cm, LM 60 W, E27

88191 Multicolor, Klemmbefestigung, H. 45 cm, LM 40 W, E14, R50

88192 Weiß, Klemmbefestigung, H. 45 cm, LM 40 W, E14, R50

88193 Schwarz, Klemmbefestigung, H. 45 cm, LM 40 W, E14, R50

88194 Stahl, Glas opal matt, mit flexiblem Arm und integriertem Stecker, Kippschalter, Ausl. 36 cm, inkl. LM 40 W, G9, HV

88195 Weiß, mit Schalter, Arm flexibel, H. 32 cm, LM 60 W, E27

88196 Multicolor, mit Schalter, Arm flexibel, H. 32 cm, LM 60 W, E27

88197 Weiß, mit Schalter und flexiblem Arm, Ausl. 30 cm, LM 40 W, E14, R50

88198 Multicolor, mit Schalter und flexiblem Arm, Ausl. 30 cm, LM 40 W, E14, R50

88199 Titan, mit Schalter und flexiblem Arm, Ausl. 30 cm, LM 40 W, E14, R50

88200 Metall, stahlfarbig, mit Klemmbefestigung, verstellbar bis 90 cm, LM 60 W, E27

88201 Metall, multicolor, mit Klemmbefestigung, verstellbar bis 90 cm, LM 60 W, E27

88202 Metall, weiß, mit Klemmbefestigung, verstellbar bis 90 cm, LM 60 W, E27

mit Sockel und Klemmvorrichtung



88180
€ 53,95

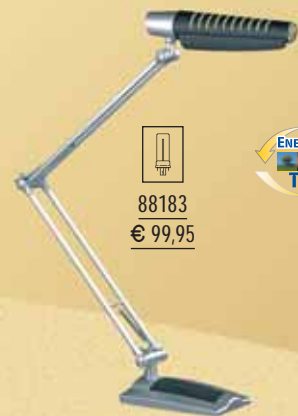

88183
€ 99,95

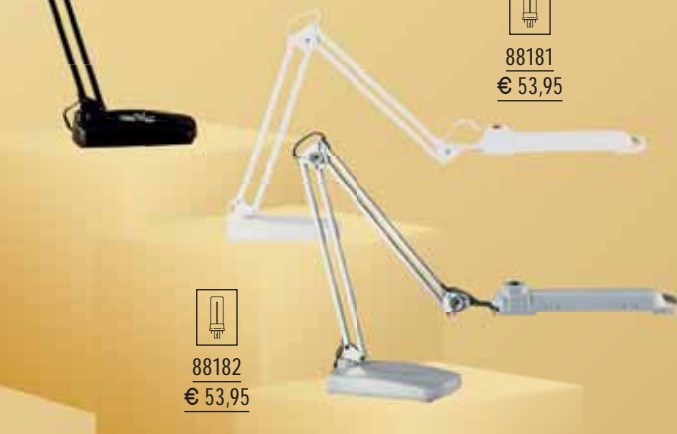

88181
€ 53,95



88182
€ 53,95



88184
€ 19,95



88185
€ 19,95



88186
€ 29,95



88187
€ 18,95



88188
€ 23,50



88189
€ 39,95

mit integriertem Schalter und Schutzkontaktstecker



88190
€ 18,95



88191
€ 14,50



88193
€ 14,50



88194
€ 20,95

mit integriertem Schalter und Schutzkontaktstecker



88195
€ 18,95



88196
€ 16,50



88198
€ 16,50



88200
€ 24,50



88202
€ 24,50



88197
€ 18,95



88199
€ 16,50



88201
€ 24,50

STRAHLERSERIEN



88203
€ 46,95

88204
€ 64,95

88205
€ 139,95

88206
€ 20,95

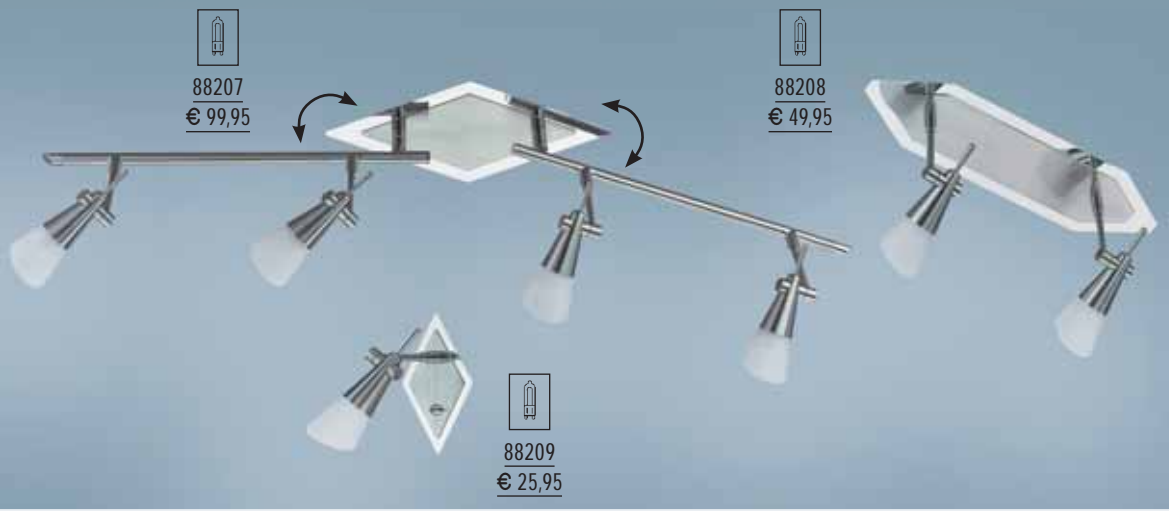

88207
€ 99,95

88208
€ 49,95

88209
€ 25,95



88210
€ 55,50

88211
€ 99,50

88212
€ 89,50

88213
€ 35,50



88214
€ 37,95

88215
€ 15,95

88218
€ 37,95

88216
€ 27,95

88217
€ 15,95

88203 Nickel matt, Glas opal matt, L. 40 cm, inkl. LM 2x9 W, E14

88204 Nickel matt, Glas opal matt, L. 64 cm, inkl. LM 3x9 W, E14

88205 Nickel matt, Glas opal matt, mit 2 Gelenken, L. 180 cm, inkl. LM 6x9 W, E14

88206 Nickel matt, Glas opal matt, mit Schalter, Ausl. 15 cm, inkl. LM 9 W, E14

88207 Nickel matt/Chrom, Glas opal matt, Arme beweglich, L. 90 cm, inkl. LM 4x40 W, G9, HV

88208 Nickel matt/Chrom, Glas opal matt, L. 37 cm, inkl. LM 2x40 W, G9, HV

88209 Nickel matt/Chrom, Glas opal matt, mit Schalter, L. 23 cm, inkl. LM 40 W, G9, HV

88210 Buche, Glas alabasterfarbig, L. 34 cm, B. 7 cm, Ausl. 18 cm, LM 2x40 W, E14, R50

88211 Buche, Glas alabasterfarbig, L. 27 cm, B. 27 cm, Ausl. 18 cm, LM 3x40 W, E14, R50

88212 Buche, Glas alabasterfarbig, L. 57 cm, B. 7 cm, Ausl. 18 cm, LM 3x40 W, E14, R50

88213 Buche, Glas alabasterfarbig, L. 14 cm, B. 10 cm, Ausl. 18 cm, LM 40 W, E14, R50

88214 Metall, weiß, L. 60 cm, Ausl. 20 cm, LM 3x60 W, E27, R80

88215 Metall, weiß, mit Wippschalter, Ø 9,5 cm, Ausl. 20 cm, LM 60 W, E27, R80

88216 Metall, weiß, L. 38 cm, Ausl. 20 cm, LM 2x60 W, E27, R80

88217 Metall, weiß, mit Klemme, Ø 9,5 cm, Ausl. 25 cm, LM 60 W, E27, R80

88218 Metall, weiß, Ø 26 cm, Ausl. 20 cm, LM 3x60 W, E27, R80



STRAHLERSERIEN

88219 Stahl, Glas teilsatiniert, L. 35 cm, B. 35 cm, Ausl. 18 cm, inkl. LM 4x40 W und 4x25 W, G9, HV

88220 Stahl, Glas teilsatiniert, schwenkbar, L. 189 cm, Ausl. 14 cm, inkl. LM 6x40 W und 3x25 W, G9, HV

88221 Stahl, Glas teilsatiniert, L. 54 cm, Ausl. 15 cm, inkl. LM 2x40 W und 3x25 W, G9, HV

88222 Nickel satiniert/chrom, mit Schalter, H. 13 cm, inkl. LM 50 W, GU10, HV

88223 Nickel satiniert/chrom, mit 2 Schaltern, L. 31 cm, inkl. 2x50 W, GU10, HV

88224 Nickel satiniert/chrom, L. 70 cm, inkl. 4x50 W, GU10, HV

88225 Altmessing, Glas alabasterfarbig, Ø 25 cm, Ausl. 7 cm, inkl. LM 3x40 W, G9, HV

88226 Altmessing, Glas alabasterfarbig, L. 47,5 cm, B. 10 cm, Ausl. 16 cm, inkl. LM 2x40 W, G9, HV

88227 Altmessing, Glas alabasterfarbig, mit Kippschalter, Ø 5 cm, Ausl. 13 cm, inkl. LM 40 W, G9, HV

88228 Altmessing, Glas alabasterfarbig, L. 90 cm, B. 10 cm, Ausl. 16 cm, inkl. LM 4x40 W, G9, HV

88229 Stahl, Glas alabasterfarbig, Ø 25 cm, Ausl. 7 cm, inkl. LM 3x40 W, G9, HV

88230 Stahl, Glas alabasterfarbig, L. 47,5 cm, B. 10 cm, Ausl. 16 cm, inkl. LM 2x40 W, G9, HV

88231 Stahl, Glas alabasterfarbig, mit Kippschalter, Ø 5 cm, Ausl. 13 cm, inkl. LM 40 W, G9, HV

88232 Stahl, Glas alabasterfarbig, L. 90 cm, B. 10 cm, Ausl. 16 cm, inkl. LM 4x40 W, G9, HV



88219
€ 84,95



88220
€ 99,95



88221
€ 54,95



88222
€ 17,95



88223
€ 35,95



88224
€ 67,95



88225
€ 49,95



88226
€ 33,95



88227
€ 14,95



88228
€ 56,95



88229
€ 49,95



88230
€ 33,95



88231
€ 14,95



88232
€ 58,95



88233
€ 169,95

88234
€ 109,95

88235
€ 239,95



88236
€ 159,95

88237
€ 99,95

88238
€ 229,95



88239
€ 134,95

88240
€ 179,95



88241
€ 184,95

88242
€ 84,95

88243
€ 129,95

88244
€ 174,95



88245
€ 179,95

88246
€ 79,95

88247
€ 114,95

88248
€ 149,95



88249
€ 154,95

88250
€ 68,95

88251
€ 249,95

88252
€ 189,95

88253
€ 129,95

88233 Nickel matt/chrom, Glas opal matt, L. 40 cm, Ausl. 13 cm, inkl. LM 2x40 W, G9, HV

88234 Nickel matt/chrom, Glas opal matt, mit Schalter, L. 12 cm, Ausl. 13 cm, inkl. LM 40 W, G9, HV

88235 Nickel matt/chrom, Glas opal matt, L. 60 cm, Ausl. 13 cm, inkl. LM 3x40 W, G9, HV

88236 Messing matt/blank abgesetzt, Glas opal matt, L. 40 cm, Ausl. 13 cm, inkl. LM 2x40 W, G9, HV

88237 Messing matt/blank abgesetzt, Glas opal matt, mit Schalter, L. 12 cm, Ausl. 13 cm, inkl. LM 40 W, G9, HV

88238 Messing matt/blank abgesetzt, Glas opal matt, L. 60 cm, Ausl. 13 cm, inkl. LM 3x40 W, G9, HV

88239 Nickel matt/chrom, L. 40 cm, Ausl. 12 cm, inkl. LM 2x50 W, GU10, HV

88240 Nickel matt/chrom, Ø 25 cm, Ausl. 12 cm, inkl. LM 3x50 W, GU10, HV

88241 Nickel matt/chrom, L. 60 cm, Ausl. 12 cm, inkl. LM 3x50 W, GU10, HV

88242 Nickel matt/chrom, L. 12 cm, Ausl. 12 cm, inkl. LM 50 W, GU10, HV

88243 Messing matt/blank abgesetzt, L. 40 cm, Ausl. 12 cm, inkl. LM 2x50 W, GU10, HV

88244 Messing matt/blank abgesetzt, Ø 25 cm, Ausl. 12 cm, inkl. LM 3x50 W, GU10, HV

88245 Messing matt/blank abgesetzt, L. 60 cm, Ausl. 12 cm, inkl. LM 3x50 W, GU10, HV

88246 Messing matt/blank abgesetzt, L. 12 cm, Ausl. 12 cm, inkl. LM 50 W, GU10, HV

88247 Weiß, L. 40 cm, Ausl. 12 cm, inkl. LM 2x50 W, GU10, HV

88248 Weiß, Ø 25 cm, Ausl. 12 cm, inkl. LM 3x50 W, GU10, HV

88249 Weiß, L. 60 cm, Ausl. 12 cm, inkl. LM 3x50 W, GU10, HV

88250 Weiß, L. 12 cm, Ausl. 12 cm, inkl. LM 50 W, GU10, HV

NIEDERVOLT

88251 Chrom matt/nickel satiniert, L. 60 cm, Ausl. 20 cm, inkl. LM 3x35 W, GU5,3, NV

88252 Chrom matt/nickel satiniert, L. 40 cm, Ausl. 20 cm, inkl. LM 2x35 W, GU5,3, NV

88253 Chrom matt/nickel satiniert, L. 20 cm, B. 20 cm, inkl. LM 35 W, GU5,3, NV

ENERGIESPAREN



Die Vorteile von Energiesparlampen in der Übersicht:

25 W	→	5 W
40 W		7 W*
40 W		9 W*
60 W		11 W
75 W		15 W
100 W		20 W
120 W		23 W

* Typenabhängig

bis zu 80% Stromersparnis!

Sparbeispiel:



60 W Glühlampen verursachen in 10.000 h Stromkosten von 120,-€*

11 W Energiesparlampen dagegen nur 22,-€*

Ersparnis über 98,-€*

* kWh = 0,20 €

OFFICELEUCHTEN

88254 Stahl, L. 100 cm, B. 13 cm, Abhängung ca. 150 cm, inkl. LM 2x18 W, T8/TL-D

88255 Stahl, L. 130 cm, B. 13 cm, Abhängung ca. 150 cm, inkl. LM 2x30 W, T8/TL-D

88256 Stahl, L. 160 cm, B. 13 cm, Abhängung ca. 150 cm, inkl. LM 2x36 W, T8/TL-D

88257 Stahl, L. 121 cm, B. 8 cm, H. 15,5 cm, Abhängung ca. 150 cm, inkl. Philips LM 54 W,T5/TL

88258 Abdeckung opal, L. 67 cm, inkl. stromsparendem EVG und LM 2x18 W, T8

88259 Abdeckung opal, L. 128 cm, inkl. stromsparendem EVG und LM 2x36 W, T8

88260 Stahl, Glas opal matt, L. 32 cm, B. 32 cm, inkl. LM 22 W, 2GX13

88261 Stahl, Glas satiniert, Ø 50 cm, H. 40 cm, inkl. LM 38 W, TC-DD, GR10q

 L. 100 cm 88254 € 84,95	 L. 130 cm 88255 € 114,95	 L. 160 cm 88256 € 149,95
 88257 € 159,95		
 L. 67 cm 88258 € 39,95		 L. 128 cm 88259 € 49,95
 88260 € 99,95		
 88261 € 134,95		

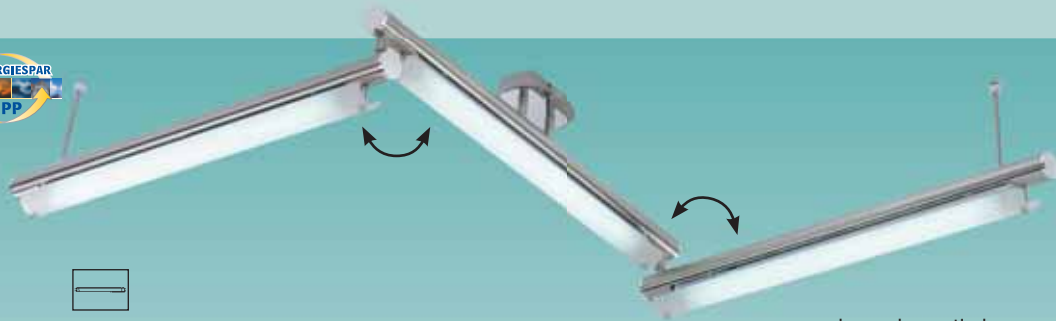

88262
€ 199,95

auch gerade montierbar

88262 Nickel satiniert, Glas satiniert, L. 220 cm, inkl. LM 3x13 W, T5



88263
€ 149,95

auch gerade montierbar

88263 Nickel satiniert, Glas satiniert, L. 150 cm, inkl. LM 2x13 W, T5



88264
€ 359,95

88264 Edelstahl matt, Glas weiß matt/transparent, L. 100 cm, B. 22 cm, H. 7 cm, inkl. Osram LM 2x39 W, T5

88265 Nickel matt, Acryl weiß, Ø 40 cm, inkl. LM 32 W, G10q

88266 Metall, grau lackiert, Glas weiß serigraphiert, L. 93 cm, B. 16 cm, H. 7 cm, inkl. LM 2x39 W/830, T5

88267 Metall, grau lackiert, Glas weiß serigraphiert, L. 21 cm, B. 21 cm, Ausl. 7 cm, inkl. LM 18 W, G24d-2



88265
€ 82,95



88266
€ 298,95

88268 Metall, grau lackiert, Glas weiß serigraphiert, L. 34 cm, B. 34 cm, Ausl. 7 cm, inkl. LM 36 W, 2G10



88267
€ 119,95

88268
€ 168,95

BADLEUCHTEN

88269 Glas sandgestrahlt weiß,
L. 34 cm, B. 34 cm, H. 8 cm,
inkl. LM 150 W, R7s, 78 mm, HV



88269
€ 109,95

88270 Chrom, mattiertes Glas,
L. 35 cm, B. 35 cm,
inkl. LM 9x20 W, G4, NV



88270
€ 127,95

88271 Chrom, Ø 36 cm,
Ausl. 13 cm, inkl. LM 16x10 W, G4,
NV



88271
€ 169,95

88272 Chrom, Glas opal, Ø 28 cm,
H. 25 cm, IP44,
inkl. Osram LM 5x25 W, G9, HV



88272
€ 99,95



88273
€ 29,95

88273 Chrom, Glas opal,
mit Zugschalter, H. 20 cm, Ausl. 7 cm,
IP44, inkl. Osram LM 25 W, G9, HV

88274 Chrom, satiniertes Glas,
H. 5 cm, L. 40 cm, Ausl. 17 cm,
inkl. LM 2x40 W, G9, HV

88275 Stahl/chrom abgesetzt,
Glas satiniert, Ø 24,5 cm, H. 7 cm,
IP44, inkl. LM 3x35 W, GZ10, HV

88276 Chrom, Glas satiniert,
H. 25 cm, Ø 8 cm, Ausl. 10 cm,
LM 40 W, E14



88274
€ 128,95

88277 Chrom, Glas opal matt,
H. 45 cm, Ø 8 cm, Ausl. 10 cm,
LM 2x40 W, E14

88278 Nickel matt, Glas weiß matt,
L. 33 cm, B. 8 cm, LM 2x40 W, E14

88279 Spiegelleuchte,
Glas satiniert, H. 70 cm, B. 60 cm,
IP44, inkl. LM 8x10 W, G4, NV

88280 Spiegelschrank
mit 3 Glasböden, mit Zugschalter und
Steckdose, L. 60 cm, B. 65 cm, IP21,
inkl. LM 10x10 W, G4, NV



88275
€ 73,95

IP44



88276
€ 99,50



88277
€ 128,50



88278
€ 55,95



beleuchteter Spiegel

88279
€ 194,95



beleuchteter Spiegelschrank

88280
€ 299,95

Spiegelklemmleuchte IP44



88281
€ 119,95

Wandspiegelleuchte mit Gelenkarm



88282
€ 89,00

Schrankaufbauleuchte



88283
€ 69,95

Spiegelklemmleuchte



88284
€ 47,95

Spiegelklemmleuchte



88285
€ 42,95



Ø 43 cm
88286
€ 47,95



Ø 52 cm
88287
€ 59,95

IP44



88288
€ 29,95

IP44



88289
€ 19,95



chrom
88290
€ 13,95



nickel matt
88291
€ 13,95



IP43



88292
€ 69,95



Ø 25 cm
88293
€ 35,65



Ø 30 cm
88294
€ 41,75



88295
€ 19,95



L. 60 cm
88298
€ 79,95



L. 36 cm
88297
€ 55,95



88296
€ 84,95



L. 35 cm
88299
€ 39,95

mit Schalter und Steckdose

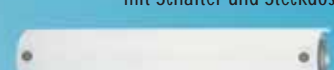

L. 57 cm
88300
€ 59,95

mit Schalter und Steckdose

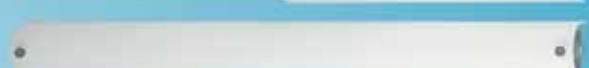

88301
€ 69,95

mit Flächenschalter



88302
€ 32,95

mit Flächenschalter



88303
€ 37,95

mit Flächenschalter und Steckdose



88281 Chrom, Glas transparent/
weiß satiniert, B. 20 cm, Ausl. 16 cm,
IP44, inkl. LM 2x40 W, G9, HV

88282 Chrom, 3-fach Vergrößerung,
mit Gelenkarm, Schalter und Stecker,
Ø 22 cm, Ausl. 51 cm,
inkl. LM 16 W, T4

88283 Aluminium, H. 11 cm,
B. 5 cm, Ausl. 34 cm, inkl. LM 50 W,
GU10, HV

88284 Chrom, mit Klemme,
Ausl. 10 cm, inkl. LM 40 W, G9, HV

88285 Chrom, mit Klemme,
Ausl. 10 cm, inkl. LM 40 W, G9, HV

88286 Chrom, Glas weiß satiniert,
Ø 43 cm, LM 3x60 W, E27

88287 Chrom, Glas weiß satiniert,
Ø 52 cm, LM 4x60 W, E27

88288 Chrom, Glas opal matt,
Ø 32 cm, H. 10 cm, IP 44,
LM 60 W, E27

88289 Stahl, Glas opal, Ø 18 cm,
H. 6 cm, IP44, LM 40 W, E14

88290 Chrom, Glas opal, Ø 30 cm,
LM 60 W, E27

88291 Nickel matt, Glas opal,
Ø 30 cm, LM 60 W, E27

88292 Weiß, Glas opal seidenmatt,
H. 11,8 cm, Ø 37 cm, IP 43,
LM 2x60 W, E27

88293 Weiß, Glas opal seidenmatt,
Ø 25 cm, H. 10,2 cm, LM 60 W, E27

88294 Weiß, Glas opal seidenmatt,
Ø 30 cm, H. 10,6 cm, LM 75 W, E27

88295 Glas opal matt, geschlossen,
B. 24 cm, Ausl. 10 cm, LM 60 W, E27

88296 Stahl, Glas satiniert,
L. 57 cm, B. 7,5 cm, Ausl. 13,5 cm,
inkl. LM 2x50 W, GZ10, HV und
3x5 W, G4, NV

88297 Chrom, Glas opal matt,
mit Schalter, L. 36 cm, B. 10 cm,
inkl. LM 8 W, T5

88298 Chrom, Glas opal matt,
mit Schalter, L. 60 cm,
inkl. LM 13 W, T5

88299 Chrom, Glas satiniert,
mit Steckdose und Schalter, L. 35 cm,
LM 2x40 W, E14

88300 Chrom, Glas satiniert,
mit Steckdose und Schalter, L. 57 cm,
LM 4x40 W, E14

88301 Weiß, Glas opal
seidenglänzend, mit Flächenschalter,
L. 45,7 cm, B. 5,5 cm, H. 8 cm,
LM 3x40 W, E14

88302 Weiß, Glas opal
seidenglänzend, mit Flächenschalter,
L. 31,5 cm, LM 2x40 W, E14

88303 Weiß, Glas opal
seidenglänzend, mit Steckdose und
Flächenschalter, L. 35,5 cm,
LM 2x40 W, E14

KINDERZIMMERLEUCHTEN

88304 Wolke, rosa
mit Lillifee Motiv, über Zugschalter
getrennt schaltbar, L. 74 cm,
B. 57 cm, H. 7 cm, inkl. LM 6x40 W,
E14 und inkl. Lichtpunkte 20x1,1 W

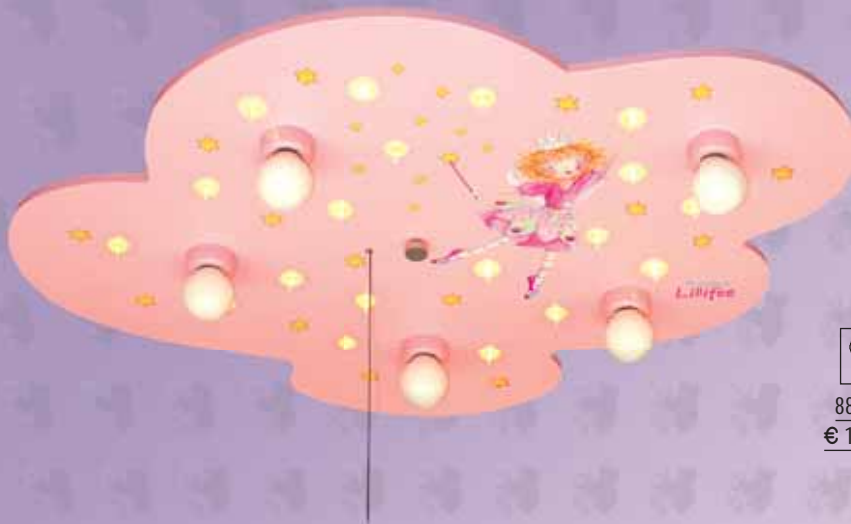

88304
€ 169,95

88305 Wolke, blau,
mit fluoreszierenden Sternen,
über Zugschalter getrennt schaltbar,
L. 74 cm, B. 57 cm, H. 7 cm,
inkl. LM 6x40 W, E14 und inkl.
Lichtpunkte 20x1,1 W

88306 Blau mit Piratenschiff Motiv,
über Zugschalter getrennt schaltbar,
L. 71 cm, B. 53 cm, H. 7 cm,
inkl. LM 5x40 W und 1x10 W, E14

88307 Schwarz/weiß, Strahler
titanfarbig, Ø 38 cm, H. 18 cm,
inkl. LM 3x40 W, E14, R50

88308 Schwarz mit Totenkopf
Motiv, Strahler titanfarbig, L. 55 cm,
B. 36 cm, inkl. LM 3x40 W, E14, R50

88309 Rosa, Strahler titanfarbig,
L. 55 cm, B. 38 cm, inkl. LM 3x40 W,
E14, R50



88305
€ 147,50



88306
€ 169,95



88307
€ 69,95



88308
€ 69,95

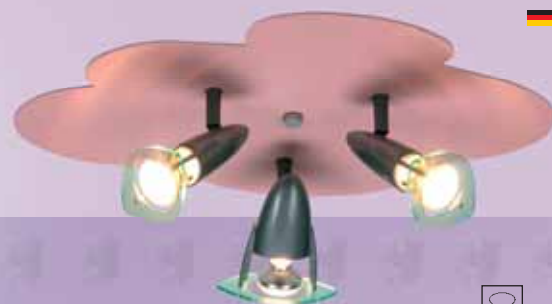

88309
€ 59,95

SEILSYSTEM



H. 250 mm, höhenverstellbar, 180° schwenkbar, geeignet für Seilabstände 80-230 mm, LM 50 W, GU5,3, NV

88310 mattchrom € 27,95

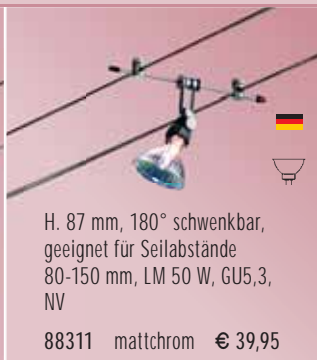

H. 87 mm, 180° schwenkbar, geeignet für Seilabstände 80-150 mm, LM 50 W, GU5,3, NV

88311 mattchrom € 39,95



H. 80 mm, 355° drehbar, 270° schwenkbar, geeignet für Seilabstände 100 mm, LM 50 W, GU5,3, NV

88312 mattchrom € 44,95



Ø 55 mm, 355° drehbar, 270° schwenkbar, geeignet für Seilabstände 100 mm, LM 50 W, GU5,3, NV

88313 mattchrom € 74,95



H. 120 mm, höhenverstellbar, 180° schwenkbar, geeignet für Seilabstände 80-230 mm, LM 50 W, GU5,3, NV

88314 mattchrom € 25,95



H. 50 mm, Ø 22 mm, geeignet für Seilabstände 80-150 mm, inkl. LM 20 W, G4, NV

88315 mattchrom € 42,95



Adapter für Pendelleuchte 88317, horizontal/vertikal, Seilabstände 100 mm, max. 70 W

88316 mattchrom € 19,95



Ø 86 mm, Glas weiß, Glas-H. 118 mm, Seillänge 1500 mm, LM 50 W, GY6,35, NV

88317 mattchrom € 124,95

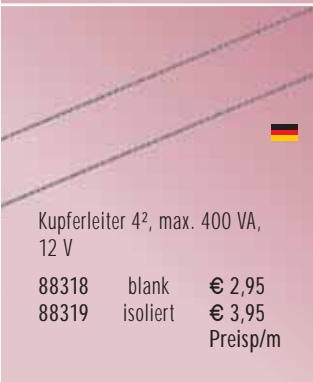

Kupferleiter 4², max. 400 VA, 12 V

88318 blank € 2,95

88319 isoliert € 3,95

Preis/m



Montageset für gerade und schräge Montageflächen, isoliert zur Montagefläche, für alle Installationslängen, bestehend aus: 4x Spannelement, Montagematerial, Einspeisung und Anschlussleitung 4 mm², 1m Länge

88320 mattchrom € 62,95



Ringkerntransformator, Kunststoffgehäuse weiß, Anschlussleitung 4 mm² bzw. 6 mm², 0,5 m Glasrohrsicherung 5x20 mm primärseitig, Überlast- und Übertemperaturschutz, H. 65 mm

88321 50-105 VA, Ø 125 mm € 84,95

88322 100-200 VA, Ø 125 mm € 94,95

88323 150-300 VA, Ø 143 mm € 125,00

UNTERBAULEUCHTEN



3-er Set, Funktionsleuchten zum An- und Unterbau, mit einem Schalter, jeweils 50 cm Verbindungsleitung zwischen den Leuchten, elektronischer Trafo, L. 140 mm, B. 125 mm, Stahl, IP20, inkl. LM 3x20 W, G4, NV

88324 stahl € 49,95



Unterbauleuchte, mit Schalter, L. 82 cm, B. 8 cm, H. 3 cm, inkl. Trafo, 2 m Zuleitung und LM 3x20 W, G4, NV

88325 titan € 41,95



Unterbauleuchte, mit Schalter, L. 55 cm, B. 8 cm, H. 3 cm, inkl. Trafo, 2 m Zuleitung und LM 2x20 W, G4, NV

88326 titan € 33,95

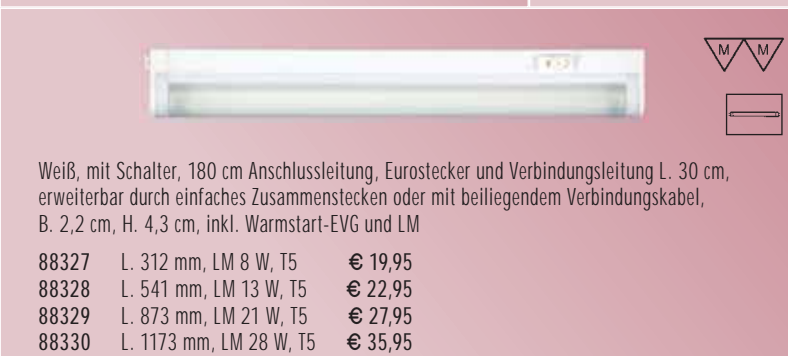

Weiß, mit Schalter, 180 cm Anschlussleitung, Eurostecker und Verbindungsleitung L. 30 cm, erweiterbar durch einfaches Zusammenstecken oder mit beiliegendem Verbindungskabel, B. 2,2 cm, H. 4,3 cm, inkl. Warmstart-EVG und LM

88327 L. 312 mm, LM 8 W, T5 € 19,95

88328 L. 541 mm, LM 13 W, T5 € 22,95

88329 L. 873 mm, LM 21 W, T5 € 27,95

88330 L. 1173 mm, LM 28 W, T5 € 35,95



Schwenkbare Anbauleuchte, titanfarbig, mit Schalter, schwarze Anschlussleitung 1,8 m mit Eurostecker, perforiertes Abdeckglas, H. 2,8 cm, B. 8,4 cm, inkl. EVG und LM

88331 L. 347 mm, LM 8 W, T5 € 22,95

88332 L. 575 mm, LM 13 W, T5 € 25,95

88333 L. 925 mm, LM 21 W, T5 € 37,95



Halterung Metall pulverbeschichtet, Endkappen Kunststoff weiß, Abdeckung Kunststoff prisma-tisch, mit Wippschalter und EVG, B. 3,5 cm, H. 5,8 cm, IP20

88334 L. 670 mm, LM 18 W, G13 € 35,95

88335 L. 975 mm, LM 30 W, G13 € 41,95

88336 L. 1280 mm, LM 36 W, G13 € 45,95

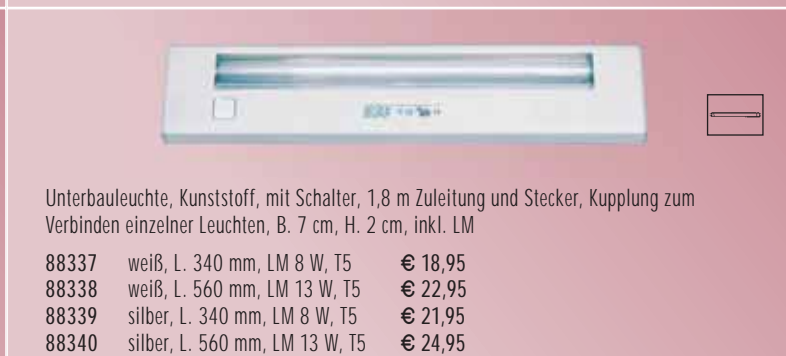

Unterbauleuchte, Kunststoff, mit Schalter, 1,8 m Zuleitung und Stecker, Kupplung zum Verbinden einzelner Leuchten, B. 7 cm, H. 2 cm, inkl. LM

88337 weiß, L. 340 mm, LM 8 W, T5 € 18,95

88338 weiß, L. 560 mm, LM 13 W, T5 € 22,95

88339 silber, L. 340 mm, LM 8 W, T5 € 21,95

88340 silber, L. 560 mm, LM 13 W, T5 € 24,95

NIEDERVOLT-SCHIENENSYSTEME

Für alle Systeme gilt:

Trafomontage variabel, jederzeit erweiterungsfähig, viele zusätzliche Systemteile auf Anfrage!

Hochleitfähige Kupferrohre (KR)
Osram-Qualitäts-Halogenlampen
Eleganter, rechteckiger Qualitäts-Trafo
Tridonic 150 VA bzw. 210 VA (XL)
wertige Rohrhalter + Metall Endspitzen



1 nickel matt -stahl
KR chrom poliert



2 messing matt
KR messing matt



3 nickel matt
KR chrom matt



S-Form: 4x35 W HALOGEN Osram
leicht gebogen, L. 240 cm

- 88341 nickel matt/stahl 1 € 207,95
- 88342 messing matt 2 € 207,95
- 88343 nickel matt 3 € 179,95

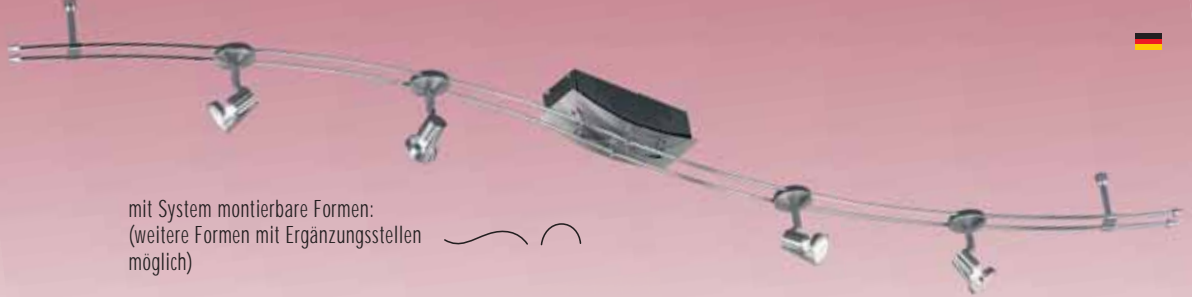

mit System montierbare Formen:
(weitere Formen mit Ergänzungsstellen möglich)



L-Form: 4x35 W HALOGEN Osram
gerade Länge 240 cm oder mit Winkel
schwenkbar 120 cm x 120 cm,
inkl. Winkel

- 88344 nickel matt/stahl 1 € 189,95
- 88345 messing matt 2 € 199,95
- 88346 nickel matt 3 € 179,95

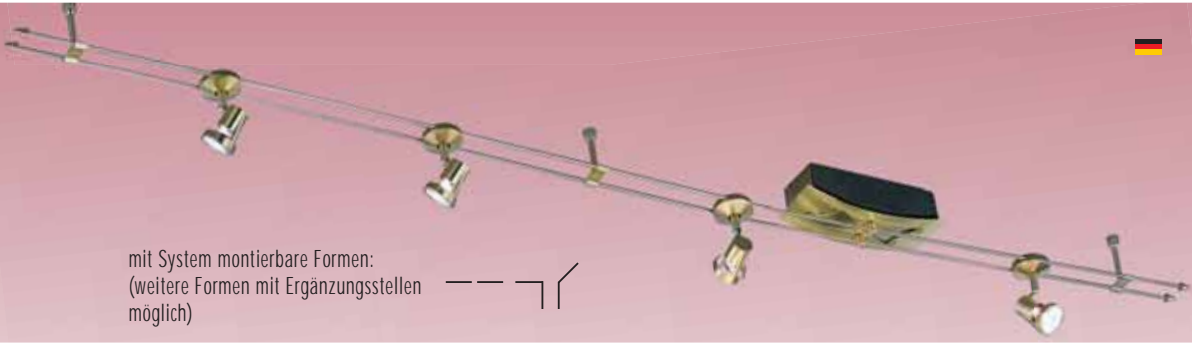

mit System montierbare Formen:
(weitere Formen mit Ergänzungsstellen möglich)



XL-Form: 6x35 W HALOGEN Osram
gerade Länge 360 cm oder mit
2 Winkeln schwenkbar
120 cm x 120 cm x 120 cm oder
zusätzlich mit 1 Kreuzung schwenkbar
240 x 120 cm, inkl. Winkel und Kreuzung

- 88347 nickel matt/stahl 1 € 289,95
- 88348 messing matt 2 € 299,95
- 88349 nickel matt 3 € 269,95

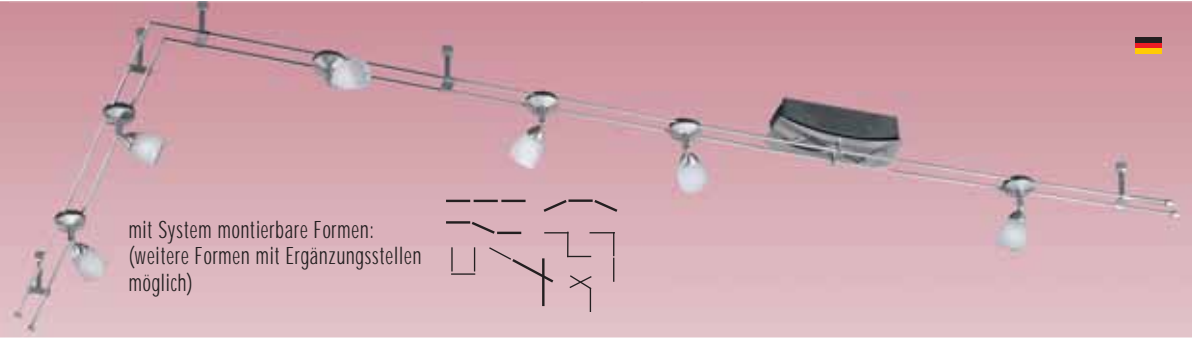

mit System montierbare Formen:
(weitere Formen mit Ergänzungsstellen möglich)



Jojo's passend zu
allen Systemen
dieser Seite

Alabaster-Kegelglas,
Gesamtlänge 200 cm,
LM 50 W, GY6,35,
höhenverstellbar, auf
dem System seitlich
oder versetzt an der
Decke montierbar.

- 88350 € 109,95
stahl
- 88351 € 109,95
messing matt



**Stromschienen
(Paar)**

L. 120 cm, gerade

- 88352 € 19,95
chrom
- 88353 € 28,95
messing matt



Deckenhalter

aus Metall/Kunststoff

- 88354 € 12,95
stahl
- 88355 € 12,95
messing matt



**0 - 130°
Winkelverbinder
(Paar) flexibel**

- 88356 € 15,95
chrom
- 88357 € 19,95
messing poliert



**Verbindungs-
stecker (Paar)**

- 88358 € 5,95
chrom
- 88359 € 6,95
messing poliert

NV-Schienen-set

Glas satiniert/klar, L. 360 cm,
mit 2 schwenkbaren Winkeln,
inkl. LM 4x35 W, GY6,35 und 6x10 W,
G4, NV

- 88360 stahl € 259,95

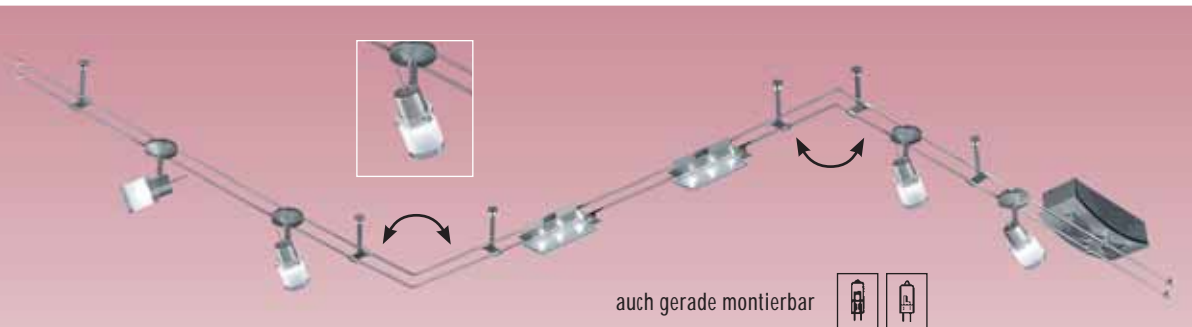

auch gerade montierbar



HOCHVOLT-SCHIENENSYSTEM

HV-Schienset

inkl. LM 4x40 W, G9, 230 V, L. 200 cm

88361 stahlfarbig € 349,50



Schienset durch Einzelkomponenten erweiterbar!
Siehe Systemkomponenten.

Flexibel – erweiterbar – individuell

- das Hochvolt-Halogen-System bietet flexible Installationen durch frei verformbare Kunststoff-Stromschienen, Flexverbinder und Flex-Einspeisung
- die Einspeisung ist an jeder Stelle der Schiene möglich
- kleinstmöglicher Radius der Stromschienen (100 cm) gewährleisten eine optimale Raum- und Flächennutzung
- das System kann beliebig lang montiert werden und bei einer max. Belastung von 3600 W/16 A bis zu 70 Strahler mit je 50 W aufnehmen

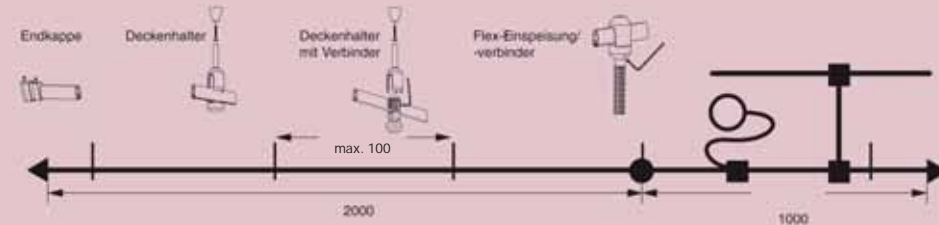
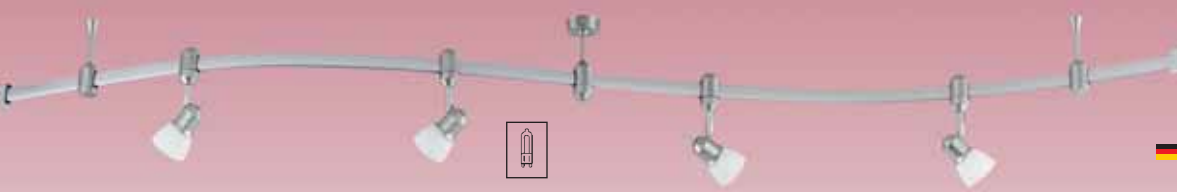

HV-Schiene
88362 € 89,95
200 cm, stahl
88363 € 49,95
100 cm, stahl

HV-Bogen
Schenkellänge 25 cm
88364 € 59,95
90°, stahl
88365 € 56,95
45°, stahl

HV-Schiensverbinder leitend
88366 € 25,95
stahl
Endkappe für HV-Schiene + HV-Bogen (ohne Abbildung)
88367 € 9,95
chrom

HV-Flexverbinder
L. 40 cm
88368 € 84,95
stahl

Energiesparstrahler inkl. LM
7 W, E14, R50, 230 V
88369 € 83,95
stahl

Energiespar-Pendelleuchte
H. 125 cm, inkl. LM 7 W, E14, 230 V
88376 stahl € 119,95

Kein Trafo erforderlich!

HV-Einspeisung
L. 12,5 cm
88370 € 69,95
stahl

HV-Deckenhalter
L. 12,5 cm
88371 € 34,95
stahl
88372 € 44,95
mit Verbinder, leitend, stahl

HV-Strahler
LM 50 W, GU10, 230 V
88373 € 58,95
stahl

HV-Strahler
LM 50 W, GU10, 230 V
88374 € 69,95
stahl

HV-Strahler
LM 40 W, G9, 230 V
88375 € 68,95
stahl

HV-Schienset
Glas alabasterfarbig, schwenkbar,
L. 190 cm, B. 10 cm, Ausl. 16 cm,
inkl. LM 6x40 W, G9, HV
88377 stahl € 96,95
88378 messing matt € 96,95

HV-Schienset
individuell formbar, L. 300 cm,
inkl. LM 5x50 W, GZ10, HV
88379 nickel matt € 89,95

LED Deckeneinbauleuchten/Deckenaufbauleuchten



LED-Deckeneinbau 6-er Set bestehend aus 1 Betriebsgerät, 6 LED Mini-spots, 5x Verbindungsleitung mit AMP-Stecksystem, Linse mit 22° Ausstrahlungswinkel, Nickel gebürstet, Deckenausschnitt 40 mm, Einbautiefe 28,4 mm, Ø 46 mm, inkl. LM 6x1 W, LED, Lichtfarbe neutralweiß

88380 € 178,50

LED



LED-Ein- und Aufbauleuchtpunkt, Material Guss, titan, Ausstrahlungswinkel 16°, Ø 45 mm, H. 23 mm, inkl. LM 1x1 W, Power-LED, IP20, Lichtfarbe kaltweiß

88381 € 73,95

LED



LED-Deckeneinbauleuchte, Material Eisen, nickel matt, schwenkbar, inkl. optischer Linse 45°, inkl. LM 3x1 W, Power-LED, IP20, Lichtfarbe kaltweiß

88382 € 89,95

LED

LED Wandeinbauleuchten



LED-Wandeinbauleuchte, Material Aluminium, alu matt, Ausschnitt 70x70 mm, Einbautiefe 40 mm, L. 83 mm, B. 83 mm, inkl. LM 1x1 W, Power-LED, IP20, Lichtfarbe kaltweiß

88383 € 54,95

LED

Einputzgehäuse zu 88383, 72x72 mm, Einbautiefe 55 mm

88384 € 7,95



LED-Wandeinbauleuchte, Material Aluminium, alu matt, Ausschnitt 72x72 mm, Einbautiefe 70 mm, L. 83 mm, B. 83 mm, inkl. LM 1x1 W, Power-LED, IP20, Lichtfarbe kaltweiß

88385 € 68,95

LED

Einputzgehäuse zu 88385, 76x76 mm, Einbautiefe 75 mm

88386 € 7,95

Konverter zu 88381, 88382, 88383 und 88385

Für 1-3 W Power-LED, prim. 95-200 V, sec. 350 mA Konstantstrom

88387 € 28,95

Für 1-8 W Power-LED, prim. 95-200 V, sec. 350 mA Konstantstrom

88388 € 34,95

LED RGB für Direktanschluss 230V

PROGRAM 1: COLOUR CHANGE



LED



LED-Aufbauzylinder mit RGB Farbwechsel- und Farbstop-Programmen, Aluminium gebürstet, satiniertes Glas, Ø 80 mm, H. 40 mm, IP24, für 230 V Direktanschluss und 1,3 W, LED SMD

88389 € 174,95

LED



LED-Einbauzylinder mit RGB Farbwechsel- und Farbstop-Programmen, Aluminium gebürstet, satiniertes Glas, Deckenausschnitt 83 mm, Einbautiefe 60 mm, Ø 96 mm, H. 19 mm, IP24, für 230 V Direktanschluss und 1,3 W, LED SMD

88390 € 149,95

PROGRAM 2: COLOUR STOP

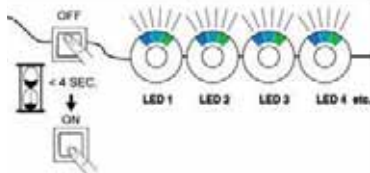

LED



LED-Einbauleuchte mit RGB Farbwechsel- und Farbstop-Programmen, Aluminiumring, einfaches Installieren in Wandeinbaudosen, Titan, satiniertes Glas, Deckenausschnitt 68 mm, Einbautiefe 60 mm,

Ø 80 mm, H. 19 mm, IP44 bei Einbau in geschlossenen Decken, für 230 V Direktanschluss inkl. Wandeinbaudose und 1,3 W, LED SMD

88391 € 149,95

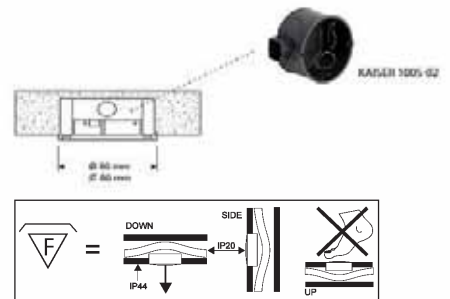

LED Bodeneinbaustrahler

LED



LED-Bodeneinbaustrahler, nickel gebürstet, Ring aus Aluminium-Druckguss, Polycarbonatscheibe mattiert, Gehäuse aus Thermoplast, Einbautiefe 84 mm, Einbauöffnung 81 mm, Ø 84 mm, befahrbar und wasserdicht, IP 68, inkl. Einbau-gehäuse und 9xSMD-LED, 1,2 W

Lichtfarbe kaltweiß

88392 € 60,70

Lichtfarbe blau

88393 € 60,70

Elektronischer Konverter für 88392 und 88393, 0-9 W, Eingangsspannung 110-240 V, Ausgangsspannung 24 V DC

88394 € 22,60



LED Bodeneinbauleuchten für Direktanschluss 230V

LED



LED-Bodeneinbauleuchte, Edelstahl, Glas klar, inkl. optischer Linse 10°, Einbauöffnung 90 mm, Einbautiefe 115 mm, Ø 135 mm, IP67, inkl. Montagehülse, Konverter für 230 V Direktanschluss und 3x1 W, Power-LED, Lichtfarbe kaltweiß

88395 € 349,95

LED



LED-Bodeneinbauleuchte, Edelstahl, Glas satiniert, inkl. optischer Linse 30°, Einbauöffnung 90 mm, Einbautiefe 135 mm, L. 100 mm, B. 100 mm, IP65, inkl. Konverter für 230 V Direktanschluss und 1x1 W, Power-LED, Lichtfarbe kaltweiß

88396 € 189,95

LED

LED

LED-Tischleuchte mit flexiblem Arm und Glasfuß, Metall, nickel matt, Ausstrahlungswinkel 50°, H. 500 mm, Fuß 130x130 mm, inkl. Konverter und 1xPower-LED 2 W, Lichtfarbe warmweiß

88397 € 229,95

LED



LED-Leuchte mit flexiblem Arm zur Wandbefestigung, nickel matt, Ausstrahlungswinkel 30°, L. 400 mm, Kopf-Ø 32 mm, inkl. Konverter und 1xPower-LED 2 W, Lichtfarbe warmweiß

88398 € 169,95

LED



LED-Einbaustrahler, Aluminium, nickel matt, 20° schwenkbar und 360° drehbarer Lichtstrahl, Ausstrahlungswinkel 30°, Deckenausschnitt 51 mm, Einbautiefe 50 mm, Ø 70 mm, IP52, 1xPower-LED 2 W, Lichtfarbe warmweiß

88399 € 129,95

LED



Einbauhülse zu 88400, Ø 16 mm, H. 35 mm

88401 € 2,95

Konverter zu 88400, für 1-40 LED á 0,5 W, 190/250 V AC, 24 V DC, 220 mA

88402 € 69,95

LED-Einbauleuchte, Gehäuse aus Messing, inkl. Federn zur Montage in abgehängte Decken oder in Decken-/Wandgehäuse, nickel matt, Ausstrahlungswinkel 30°, Deckenausschnitt 15 mm, Einbautiefe 24 mm, Ø 20 mm, IP65, 1xPower-LED 0,5 W, Lichtfarbe kaltweiß

88400 € 29,95

LED



LED-Wandeinbauleuchte für indirekte Beleuchtung, Aluminium, Ausstrahlungswinkel 70°, Ausschnitt 52 mm, Einbautiefe 42 mm, Ø 62 mm, IP65, 1xPower-LED 2 W, Lichtfarbe warmweiß

88403 € 129,95**LED-Bodeneinbauleuchten**

LED



LED-Bodeneinbaustrahler, Edelstahl, Glas klar, befahrbar, 20° schwenkbar und 360° drehbarer Lichtstrahl, Ausstrahlungswinkel 30°, Einbauöffnung 48 mm, Einbautiefe 124 mm, Ø 70 mm, IP67, inkl. Konverter und 1xPower-LED 2 W, Lichtfarbe warmweiß

88404 € 259,95

LED



LED-Bodeneinbaustrahler, Edelstahl, Glas klar, begehbar, schwenkbarer Lichtstrahl 25°, Ausstrahlungswinkel 30°, Einbauöffnung 48 mm, Einbautiefe 60 mm, Ø 70 mm, IP66, 1xPower-LED 2 W, Lichtfarbe warmweiß

88405 € 174,95

LED



LED-Bodeneinbaustrahler, nickel matt, Glas satiniert, begehbar, starr, optimal für Parkett und Teppichböden, Einbauöffnung 30 mm, Einbautiefe 6 mm, Ø 35 mm, IP65, inkl. 1xPower-LED 1 W, Lichtfarbe warmweiß

88407 € 64,95

Einbauhülse zu 88404 und 88405

88406 € 12,95

Einbauhülse zu 88407

88408 € 5,95

Einbauring zu 88407

88409 € 4,95**Konverter zu 88407**

Für 1-4 LED á 1 W, 190/250 V AC, 18 V DC, 220 mA

88410 € 44,95**Konverter zu 88399, 88403, 88404, 88405**

Für 1-6 LED á 2 W, 190/250 V AC, 24 V DC, 600 mA

88411 € 49,95**LED-Bodeneinbauleuchten mit niedriger Einbauhöhe**

Ø 87 mm
88412 € 35,70



87x87 mm
88413 € 35,70

LED

LED-Einbauleuchte mit niedriger Einbauhöhe von 7 mm, Edelstahlabdeckung, Gehäuse und Lichtaustrittöffnung aus schlagzähem Polycarbonat, Farbfolien für verschiedene Lichtfarben im Lieferumfang enthalten, Einbauöffnung 78 mm, IP20, inkl. 1x0,6 W, LED, Lichtfarbe kaltweiß

Montagezubehör 2-polig mit Raststecksystem, max 2A

LED-Verteiler, 10-fach

88414 € 6,95

LED-Kabel Stecker/Buchse, L. 5m

88415 € 4,95

Elektronischer Konverter für 88412 und 88413, 0-9 W, Eingangsspannung 110-240 V, Ausgangsspannung 24 V DC

88394 € 22,60

NV-Halogen Einbaustrahler, rein Messing, ENEC 05

Hochvolt

88418-88421 starr, LM 50 W, GX5,3, 12 V		 60 75 55	88418 weiß	88419 chrom	88420 mattchrom	88421 messing	88422
			€ 18,95	€ 21,95	€ 24,95	€ 22,95	€ 8,95
88423-88426 schwenkbar, LM 50 W, GX5,3, 12 V		 68 75 55	88423 weiß	88424 chrom	88425 mattchrom	88426 messing	Bügel für Einbaustrahler zum Nachrüsten mit Hochvolt-Fassung GX10 und beidseitiger Zugentlastung
			€ 22,95	€ 27,95	€ 34,95	€ 27,95	

NV-Halogen Einbaustrahler, Guss Eisen, mit separatem Montagetopf erleichtert die Installation

88427-88430 ohne Sprengring, schwenkbar, LM 50 W, GX5,3, 12 V		 68 87 55	88427 weiß	88428 chrom	88429 mattnickel	88430 gold
			€ 14,95	€ 18,95	€ 18,95	€ 18,95

NV-Halogen Einbaustrahler, Guss

88431-88434 starr, LM 50 W, GX5,3, 12 V		 68 78 55	88431 weiß	88432 chrom	88433 mattchrom	88434 gold	
			€ 6,95	€ 7,95	€ 9,95	€ 9,95	
88435-88438 schwenkbar, LM 50 W, GX5,3, 12 V		 75 82 55	88435 weiß	88436 chrom	88437 mattchrom	88438 gold	
			€ 9,95	€ 11,95	€ 11,95	€ 11,95	
88439-88442 ohne Sprengring, starr, LM 35 W, G24, 12 V		 48 60 45	88439 weiß	88440 chrom	88441 mattchrom	88442 gold	
			€ 7,95	€ 8,95	€ 9,95	€ 9,95	
88443-88446 schwenkbar, LM 35 W, G24, 12 V		 58 64 45	88443 weiß	88444 chrom	88445 mattchrom	88446 gold	
			€ 9,95	€ 14,95	€ 14,95	€ 14,95	
88447-88450 schwenkbar, LM 50 W, GX5,3, 12 V		 75 L x B 84 55	88447 weiß	88448 chrom	88449 mattchrom	88450 gold	
			€ 15,95	€ 19,95	€ 19,95	€ 19,95	

NV-Halogen Einbaustrahler, Eisen, für alle Innenbereiche

88451-88454 starr, LM 50 W, GX5,3, 12 V		 60 80 55	88451 weiß	88452 chrom	88453 mattchrom	88454 gold	
			€ 7,95	€ 7,95	€ 7,95	€ 7,95	
88455-88458 schwenkbar, LM 50 W, GX5,3, 12 V		 68 82 55	88455 weiß	88456 chrom	88457 mattchrom	88458 gold	
			€ 9,95	€ 13,95	€ 13,95	€ 13,95	

NV-Halogen Einbaustrahler, Stahl

88459-88462 starr, LM 50 W, G 5,3, 12 V, ohne Abstandhalter		 60 80 56,5	88459 weiß	88460 chrom	88461 mattchrom	88462 gold	
			€ 7,75	€ 8,25	€ 12,15	€ 8,80	
88463-88466 schwenkbar, LM 50 W, G 5,3, 12 V, ohne Abstandhalter		 68 88 53,5	88463 weiß	88464 chrom	88465 mattchrom	88466 gold	
			€ 11,60	€ 14,90	€ 17,70	€ 16,00	
88467-88470 schwenkbar, LM 35 W, G24, 12 V, ohne Abstandhalter		 55 71 48	88467 weiß	88468 chrom	88469 mattchrom	88470 gold	
			€ 12,15	€ 14,35	€ 18,20	€ 15,45	
88471-88474 ohne Sprengring, schwenkbar, montagefreundlich, LM 50 W, G 5,3, 12 V, ohne Abstandhalter		 68 88 53,5	88471 weiß	88472 chrom	88473 mattchrom	88474 gold	
			€ 12,60	€ 14,70	€ 18,35	€ 16,25	

HV-Einbaustrahler Eisen/Messing

88475-88478
schwenkbar, LM 50 W,
GZ10, HV

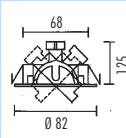

88475 weiß	88476 chrom	88477 mattchrom	88478 gold
€ 21,95	€ 21,95	€ 21,95	€ 21,95

Einbaulautsprecher

88483-88484
6/8 W, 4 Ohm, ohne
Übertrager

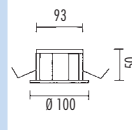

88483 weiß	88484 stahl matt
€ 64,95	€ 84,95



NV-Lichtpunkte Guss

88479-88482

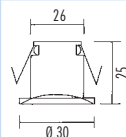

88479 weiß	88480 chrom	88481 mattchrom	88482 gold
€ 6,95	€ 6,95	€ 6,95	€ 6,95

Edelstahl – High Quality für alle Bereiche

88485
Edelstahl, starr, LM 50 W,
GX5,3, 12 V

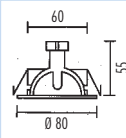

88485 Edelstahl
€ 17,95

88486
Edelstahl, schwenkbar,
LM 50 W, GX5,3, 12 V

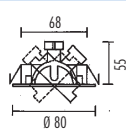

88486 Edelstahl
€ 19,95

88487
Edelstahl, ohne Spreng-
ring, schwenkbar,
LM 50 W, GX5,3, 12 V

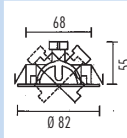

88487 Edelstahl
€ 29,95

Edelstahl weiß

88488
Edelstahl, starr, LM 50 W,
GX5,3, 12 V

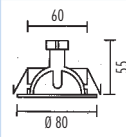

88488 weiß
€ 17,95

88489
Edelstahl, schwenkbar,
LM 50 W, GX5,3, 12 V

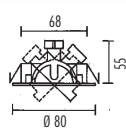

88489 weiß
€ 19,95



Einbaustrahler für Bäder/Duschen, IP65

88490
Edelstahl, Glas satiniert,
ohne Sprengring, LM 50 W,
GX5,3, 12 V

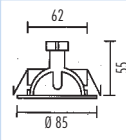

88490 Edelstahl
€ 23,95

88491
Guss, Glas satiniert, ohne
Sprengring, LM 50 W,
GX5,3, 12 V

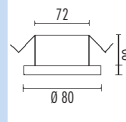

88491 weiß
€ 22,95

Einbaustrahler für Bäder/Duschen, IP44

88492
Aluminium, LM 50 W,
GU5,3, 12 V

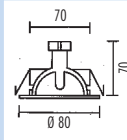

88492 alu
€ 28,95

Möbelein- und Aufbaustrahler

88493-88496
für Möbelein- und Aufbau
geeignet, inkl. Aufbau-
ring, schwenkbar,
inkl. LM 20 W,
G4, 12 V

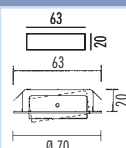

88493 weiß
€ 11,95

88494 chrom
€ 11,95

88495 titan
€ 11,95

88496 messing poliert
€ 11,95

88497-88500
für Möbelein- und Aufbau
geeignet, inkl. Aufbau-
ring, starr, inkl. LM 20 W,
G4, 12 V

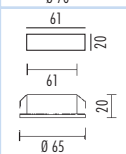

88497 weiß
€ 10,95

88498 chrom
€ 10,95

88499 titan
€ 10,95

88500 messing poliert
€ 10,95

Möbeleinbaustrahler

88501-88503
Eisen, Glas satiniert,
LM 20 W, G4, 12 V

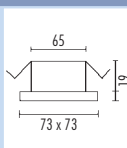

88501 weiß
€ 9,95

88502 chrom
€ 9,95

88503 mattchrom
€ 9,95

HV-Einbauleuchte für Energiesparleuchtmittel

Zubehör

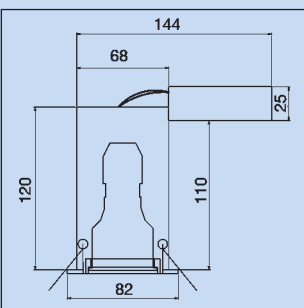
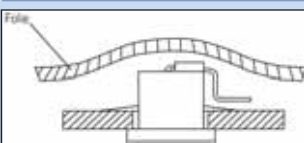

Eisen/Messing, inkl. F-Dach Zeichen, zur Montage in
oder an normal entflammbaren Oberflächen, darf mit
Wärmedämm-Matten bedeckt werden, IP20, für
Energiesparleuchtmittel MR16 7/9/11 W, GU10, HV

88504 weiß	€ 46,95
88505 mattchrom	€ 54,95



88506 € 149,95
Präsenzmelder für Deckenmontage, 360°
Erfassungsbereich, Reichweite: ca. 8 m im
Durchmesser, weiß, Deckenausschnitt Ø 68 mm, elek-
tronische Einstellung mit separater Infrarot-
Fernbedienung, IP44



Elektronischer Sicherheitstransformator mit abge-
deckten, einseitigen Schraubklemmen, primär dimm-
bar mit gängigen Phasen- und Abschnittdimmern

88508	€ 16,10
20-60 VA, L124 mm, B.37 mm, H.31 mm	
88509	€ 17,90
35-110 VA, L124 mm, B.37 mm, H.31 mm	
88510	€ 29,80
50-150 VA, L127 mm, B.42 mm, H.32 mm	



88507 € 28,95
Universale Fernbedienung für Präsenzmelder
88506, silber, Reichweite: bewölkt/dunkel
ca. 5-6 m, direkter Sonnenschein ca. 2-3 m

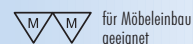

Elektronischer Einbaukonverter für Installations-
lösungen auf engem Raum, primär und sekundär mit
15 cm Anschlussleitung, dimmbar mit gängigen
Phasenabschneidern

88511	€ 19,10
20-60 VA, D. 57 mm, H. 19 mm	



Energiespar-Aufbauleuchten

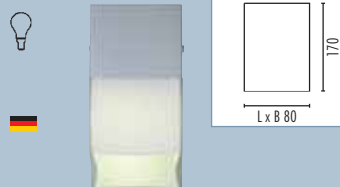

88512 € 69,50
Energiespar-Aufbauleuchte, Metall, titan-silber, Glas opal matt, LM MEGAMAN Liliput plus 11 W, E14

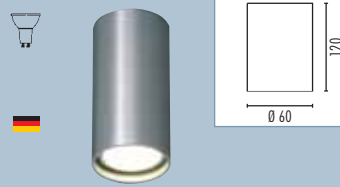

88513 € 69,50
Energiespar-Aufbauleuchte, Metall, silber eloxiert, LM MEGAMAN 11 W, GU10, HV

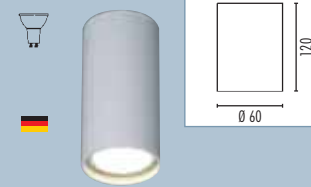

88514 € 62,50
Energiespar-Aufbauleuchte, Metall, weiß, LM MEGAMAN 11 W, GU10, HV

HV-Aufbauleuchte



88515 € 99,50
Aufbauleuchte, Metall, nickel matt, Glas satiniert, inkl. LM 60 W, G9, HV

HV- Einbauleuchten

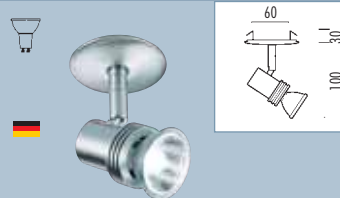

88516 € 49,95
Einbauleuchte, Eisen, nickel matt, LM 50 W, GZ10, HV

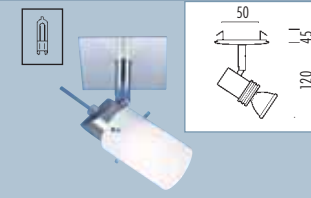

88517 € 47,00
Einbauleuchte, Metall, nickel matt/chrom, Glas satiniert, inkl. LM 1x40 W, G9, HV

NV-Einbaustrahler



88518 € 22,95
Einbauleuchte, für Auf- und Einbau geeignet, mit Aufbauring, chrom matt, LM 20 W, G4, NV



88519 € 74,95
Einbauleuchte mit Radial LED-Kranz, Guss, nickel matt, Lichtfarbe weiß, 25° schwenkbar, inkl. LED-Konverter, mit zwei 230 V-Anschlüssen ist eine separate Schaltung (NV/LED) möglich, LM 35 W, GX5,3, NV



88520 € 74,95
Einbauleuchte mit Radial LED-Kranz, Guss, nickel matt, Lichtfarbe blau, 25° schwenkbar, inkl. LED-Konverter, mit zwei 230 V-Anschlüssen ist eine separate Schaltung (NV/LED) möglich, LM 35 W, GX5,3, NV

Einbau-Downlights

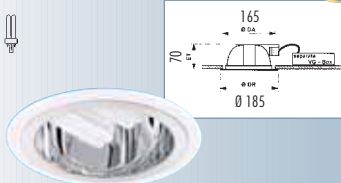

88521 € 49,95
Einbaudownlight, weiß, 2xTC-D 13 W, zusätzlich Dekoglas/-ring 88523-88525



88522 € 49,95
Einbaudownlight, weiß, 2xTC-D 18 W, zusätzlich Dekoglas/-ring 88523-88525

Dekoglas und Dekoring

88523+88524
Dekoglas und Dekoring passend für 88521 und 88522

Dekoglas satiniert



88523 € 38,95

Dekoring satiniert



88524 € 38,95

88525 € 35,95
Abdeckung, für Feuchtraum geeignet IP44, passend für 88521 und 88522



Einbau-Downlights, IP44



88526 € 89,95
Einbaudownlight, Alu-Druckguss, schwarz, Facettenreflektor Kunststoff metallisiert, Betriebsgehäuse abnehmbar, Schnellbefestigung, IP 44, LM 13 W, G24d-1

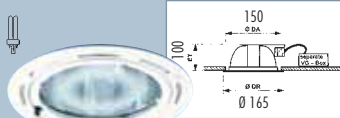

88527 € 75,95
Einbaudownlight, Alu-Druckguss, weiß, Facettenreflektor Kunststoff metallisiert, Betriebsgehäuse abnehmbar, Schnellbefestigung, IP 44, LM 13 W, G24d-1

Lichtwellenleiter-Set

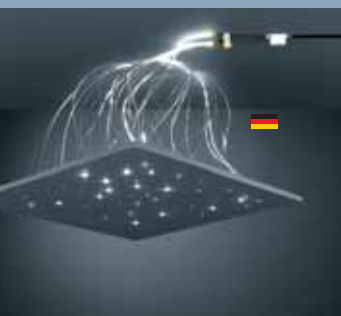

88528 € 139,95
Lichtwellenleiter „Einsteiger-Set“ bestehend aus: Mini Projektor, Durchmesser: 26 mm, Länge: 35 mm, Bestückung: 1 x Power LED, (1 W) 12V/DC 350 mA Konstantstrom, LED Farbe weiß, 1 x Netzgerät für max. 1 Power LED, B. 25 x H. 25 x L. 35 mm, 1 x Faserbündel konfektioniert, 50-teilige Mischfaser (0,5/0,75/1,0/1,5), Länge: 1,0 m



AUSSENLEUCHTEN



weiß
88529
€ 78,95

schwarz
88530
€ 78,95

500 W



schwarz
88531
€ 52,95

weiß
88532
€ 52,95

silber
88533
€ 57,95

500 W



schwarz
88534
€ 114,95

weiß
88535
€ 114,95

silber
88536
€ 124,95

88529 Weiß, Polyamid, schwenkbar, H. 25 cm, B. 24 cm, Ausl. 25 cm, IP54, LM 18 W, G24d-2

88530 wie 88529, jedoch in schwarz

88531 Schwarz, schwenkbar, B. 21,5 cm, H. 16 cm, Ausl. 20 cm, IP44, LM 150-500 W, R7s, 118 mm, HV

88532 wie 88531, jedoch in weiß

88533 wie 88531, jedoch in silber

88534 Schwarz, mit 200° Bewegungsmelder, schwenkbar, H. 23 cm, B. 21,5 cm, Ausl. 19,5 cm, IP44, LM 150-500 W, R7s, 118 mm, HV

88535 wie 88534, jedoch in weiß

88536 wie 88534, jedoch in silber

88537 Schwarz, Aluminiumguss, schwenkbar, H. 15 cm, B. 15 cm, Ausl. 16 cm, IP54, 150 W, R7s, 78 mm, HV

88538 wie 88537, jedoch in weiß

88539 wie 88537, jedoch in silber

88540 Schwarz, schwenkbar, B. 14 cm, H. 15 cm, Ausl. 15 cm, IP44, LM 60-150 W, R7s, 78 mm, HV

88541 wie 88540, jedoch in weiß

88542 wie 88540, jedoch in silber

88543 Schwarz, mit 200° Bewegungsmelder, schwenkbar, H. 23 cm, B. 14 cm, Ausl. 15 cm, IP44, LM 60-150 W, R7s, 78 mm, HV

88544 wie 88543, jedoch in weiß

88545 wie 88543, jedoch in silber

88546 Aufbaustrahler, chrom matt, H. 8 cm, B. 8 cm, Ausl. 10,5 cm, IP55, inkl. LM 50 W, GU10, HV

88547 Aufbaustrahler, anthrazit metallic, Aluminium- Druckguss, H. 10 cm, B. 9,5 cm, Ausl. 14 cm, IP55, LM 50 W, GU10, HV

88548 Anthrazit metallic, Aluminium- Druckguss, mit Erdspieß und 3 m Zuleitung mit Netzstecker, H. 28 cm, Ø 9,5 cm, L. 10 cm, IP55, LM 50 W, GU10, HV

88549 Schwarz, Aluminiumguss, mit Erdspieß und 2,5 m Zuleitung mit Netzstecker, H. 35 cm, Ø 10 cm, Ausl. 13,5 cm, IP55, LM PAR 20/50 W, E27

88550 Stahl, H. 15 cm, B. 10 cm, Ausl. 12 cm, IP44, inkl. LM 35 W, GU10, HV

88551 Edelstahl, mit Erdspieß, H. 23 cm, Ø 6 cm, inkl. Steckertrafo, 10 m Zuleitung und LM 50 W, GU5,3 NV

88552 Schwarz, Polyamid, Ø 10 cm, Ausl. 23,5 cm, IP43, LM PAR 38/80 W, E27

88553 wie 88552, jedoch in weiß

88554 Schwarz, Polyamid, mit Erdspieß und 3 m Zuleitung, H. 40 cm, Ø 10 cm, IP43, LM PAR 38/80 W, E27

88555 Edelstahl, Glas satiniert, ET. 13 cm, Einbauöffnung 13 cm, Ø 14 cm, IP65, für MEGAMAN LM 13 W, GX53

88556 Edelstahl, 36° schwenkbar, ET. 15,6 cm, Einbauöffnung 8 cm, L. 12 cm, B. 12 cm, IP67, LM 50 W, GU10, HV

88557 Einbauhülse zu Strahler 88556

88558 Edelstahl, Glas klar, DA. 7,2 cm, ET. 6 cm, Ø 10,3 cm, IP54, LM 50 W, GX5,3 NV

88559 4-fach Steckdosensäule, schwarz, Aluminiumguss, H. 50 cm, B. 15 cm, IP44

88560 2-fach Steckdosenspieß, schwarz, mit 3 m Zuleitung, H. 40 cm, B. 10,5 cm, IP43



150 W



schwarz
88537
€ 144,95

weiß
88538
€ 144,95

silber
88539
€ 144,95

150 W



schwarz
88540
€ 42,95

weiß
88541
€ 42,95

silber
88542
€ 47,95

150 W



schwarz
88543
€ 109,95

weiß
88544
€ 109,95

silber
88545
€ 119,95





88546
€ 64,95





88547
€ 37,95

mit Erdspieß





88548
€ 32,95



mit Erdspieß





88549
€ 109,95





88550
€ 33,95

mit Erdspieß





88551
€ 59,95







schwarz
88552
€ 17,95



weiß
88553
€ 16,95



mit Erdspieß





88554
€ 21,95

EINBAUSTRAHLER

STECKDOSENSÄULEN





88555
€ 85,95



Bodeneinbaustrahler



Einbauhülse zu Strahler

88556
€ 219,95

88557
€ 16,95



Bodeneinbaustrahler

Deckeneinbaustrahler





88558
€ 46,95





88559
€ 219,95





88560
€ 33,95

AUSSENLEUCHTEN

88561 Aluminium, H. 19,5 cm, Ø 7,5 cm, Ausl. 12,5 cm, IP54, inkl. LM 2x35 W, GU10, HV

88562 Silber metallic, Aluminium-Druckguss, Glas opal seidenmatt, für Auf- und Einbau geeignet, ET. 2,2 cm, Ø 27 cm, Ausl. 8 cm, IP54, LM 75 W, E27

88563 Weiß, Aluminium-Druckguss, Glas innen mattiert, Ø 26,5 cm, Ausl. 11 cm, IP54, LM 75 W, E27

88564 Weiß, Aluminium-Druckguss, Glas innen mattiert, Ø 26,5 cm, Ausl. 12,5 cm, IP54, LM 75 W, E27

88565 Schwarz, Kunststoff, Glas opal seidenmatt, H. 24 cm, B. 24 cm, Ausl. 10 cm, Deckenmontage, IP43, Wandmontage IP44, LM 75 W, E27

88566 Graphit, Aluminium-Druckguss, Kunststoffabdeckung weiß, L. 24 cm, B. 24 cm, Ausl. 12 cm, IP65, LM 60 W, E27

88567 wie 88566, jedoch in weiß

88568 Weiß, schlagfester Kunststoff, Ø 25 cm, Ausl. 8 cm, IP43, LM 2x9 W, G23

88569 Weiß, schlagfester Kunststoff, für Hausnummern geeignet, L. 24,5 cm, B. 24,5 cm, Ausl. 8 cm, IP43, LM 2x9 W, G23

88570 Weiß, schlagfester Kunststoff, mit Dämmerungsschalter, L. 24,5 cm, B. 24,5 cm, Ausl. 8 cm, IP43, LM 2x9 W, G23

88571 Weiß, Glas opal glänzend, Ø 23 cm, Ausl. 11 cm, LM 75 W, E27

88572 Weiß, Glas opal glänzend, L. 22 cm, B. 12 cm, Ausl. 10,5 cm, LM 60 W, E27

88573 Weiß, Glas opal glänzend, L. 24 cm, B. 24 cm, Ausl. 11 cm, LM 75 W, E27

88574 Weiß, Glas opal glänzend, L. 19 cm, B. 19 cm, Ausl. 10 cm, LM 60 W, E27

88575 Weiß, Aluminium-Druckguss, Glas innen mattiert, Ø 18 cm, Ausl. 10,7 cm, IP54, LM 75 W, E27

88576 Weiß, Aluminium-Druckguss, Glas innen mattiert, L. 21 cm, B. 10,7 cm, Ausl. 10 cm, IP54, LM 60 W, E27

88577 Weiß, Aluminium-Druckguss, Glas innen mattiert, L. 28 cm, B. 16 cm, Ausl. 13,5 cm, IP54, LM 100 W, E27

88578 Silber, Aluminium-Druckguss, Glas satiniert, Ø 24 cm, Ausl. 12 cm, IP54, LM 100 W, E27

88579 wie 88578, jedoch in schwarz

88580 wie 88578, jedoch in weiß

88581 Silber, Aluminium-Druckguss, Glas satiniert, H. 9,7 cm, B. 21,5 cm, Ausl. 11 cm, IP54, LM 60 W, E27

88582 wie 88581, jedoch in weiß



88561
€ 37,95



88562
€ 89,95



88563
€ 73,95



88564
€ 86,95



88565
€ 38,95



graphit
88566
€ 69,95



weiß
88567
€ 62,95



88571
€ 32,80



88572
€ 33,00



aus schlagfestem Kunststoff



88569
€ 69,50

aus schlagfestem Kunststoff, Lieferung ohne Hausnummer



88570
€ 119,50

aus schlagfestem Kunststoff und mit Dämmerungsschalter



88575
€ 44,10



10,7 x 21 cm
88576
€ 36,70



16 x 28 cm
88577
€ 37,00



silber
88578
€ 31,95



schwarz
88579
€ 31,95



weiß
88580
€ 31,95



silber
88581
€ 21,95



weiß
88582
€ 21,95

88583
€ 229,95

ENERGIESPAR
TIPP

88584
€ 164,95

ENERGIESPAR
TIPP

88585
€ 144,95

ENERGIESPAR
TIPP

schwarz
88586
€ 74,95

weiß
88587
€ 74,95

88588
€ 154,95

88589
€ 144,95

88590
€ 121,95

ENERGIESPAR
TIPP

88591
€ 189,95

ENERGIESPAR
TIPP

88592
€ 195,95

ENERGIESPAR
TIPP

88593
€ 117,95

ENERGIESPAR
TIPP

Leuchten mit Erdspieß

Ø 20 cm
88594
€ 119,50

Ø 30 cm
88595
€ 150,00

Ø 40 cm
88596
€ 179,50

Ø 50 cm
88597
€ 199,95

ENERGIESPAR
TIPP



88583 Aluminium eloxiert, Acryl weiß, Ø 26,5 cm, Ausl. 6,2 cm, mit EVG, IP44, LM 22 W, 2GX13

88584 Aluminium eloxiert, Acryl weiß, L. 29 cm, B. 29 cm, Ausl. 9 cm, mit EVG, IP44, LM 22 W, 2GX13

88585 Aluminium eloxiert, Acryl weiß, L. 39 cm, B. 7,5 cm, Ausl. 7,5 cm, mit EVG, IP44, LM 11 W, 2G7

88586 Schwarz, Polycarbonat, Blasenglas, mit Bewegungsmelder 130°, H. 29 cm, Ø 21 cm, Ausl. 21 cm, IP44, LM 100 W, E27

88587 Weiß, Polycarbonat, Blasenglas, mit Bewegungsmelder 130°, H. 29 cm, Ø 21 cm, Ausl. 21 cm, IP44, LM 100 W, E27

88588 Kunststoff graphit, Glas klar/satiniert, L. 25 cm, B. 22 cm, Ausl. 26 cm, IP44, LM 60 W, E27

88589 Graphit, Glas opal, L. 20 cm, B. 20,5 cm, Ausl. 9 cm, IP44, LM 40 W, G9, HV

88590 Graphit, Aluminium-Druckguss, Kunststoffabdeckung weiß, Ø 27 cm, Ausl. 12 cm, IP65, LM 18 W, G24q-2

88591 Anthrazit lackiert, 20 Jahre Garantie auf die Lackierung, Aluminium-Druckguss, Polycarbonat weiß, L. 30 cm, B. 30 cm, LM 2x11 W, G23

88592 Weiß lackiert, 20 Jahre Garantie auf die Lackierung, Aluminium-Druckguss, Polycarbonat weiß, L. 30 cm, B. 30 cm, LM 2x11 W, G23

88593 Weiß, Aluminium-Druckguss, Kunststoffabdeckung weiß, Ø 27 cm, Ausl. 12 cm, IP65, LM 18 W, G24q-2

88594 Schlagfestes, weißes Polyäthylen, UV-beständig, Ø 20 cm, mit Erdspieß und 500 cm Zuleitung mit Netzstecker, IP44, ohne LM TC-TSE/max. 9 W, E27

88595 Schlagfestes, weißes Polyäthylen, UV-beständig, Ø 30 cm, mit Erdspieß und 500 cm Zuleitung mit Netzstecker, IP44, ohne LM TC-TSE/max. 9 W, E27

88596 Schlagfestes, weißes Polyäthylen, UV-beständig, Ø 40 cm, mit Erdspieß und 500 cm Zuleitung mit Netzstecker, IP44, ohne LM TC-TSE/max. 11 W, E27

88597 Schlagfestes, weißes Polyäthylen, UV-beständig, Ø 50 cm, mit Erdspieß und 500 cm Zuleitung mit Netzstecker, IP44, ohne LM TC-TSE/max. 15 W, E27

AUSSENLEUCHTEN

88598 Braun-messing, Aluminiumguss, Acrylglas klar, H. 135,5 cm, Ø 26 cm, IP44, LM 75 W, E27

88599 Braun-messing, Aluminiumguss, Acrylglas klar, mit 120° Bewegungsmelder, H. 45 cm, Ø 26 cm, Ausl. 32 cm, IP44, LM 75 W, E27

88600 Braun-messing, Aluminiumguss, Acrylglas klar, H. 45 cm, Ø 26 cm, Ausl. 32 cm, IP44, LM 75 W, E27

88601 Braun-messing, Aluminiumguss, Acrylglas klar, H. 45 cm, Ø 26 cm, Ausl. 32 cm, IP44, LM 75 W, E27

88602 Braun-messing, Aluminiumguss, Acrylglas klar, H. 56,5 cm, Ø 26 cm, IP44, LM 75 W, E27

88603 Braun-messing, Aluminiumguss, Acrylglas klar, H. 207 cm, Ø 64 cm, IP44, LM 3x75 W, E27

88604 Erdeinbausockel, H. 40 cm, Ø 23 cm

88605 Schwarz, Aluminiumguss, klares Kathedralglas, H. 230 cm, Ø 82 cm, IP23, LM 3x75 W, E27

88606 wie 88605, jedoch in weiß

88607 Schwarz, Aluminiumguss, klares Kathedralglas, mit Montageplatte, H. 43 cm, B. 23 cm, Ausl. 29 cm, IP23, LM 75 W, E27

88608 wie 88607, jedoch in weiß

88609 Schwarz, Aluminiumguss, klares Kathedralglas, H. 50 cm, B. 23 cm, IP23, LM 75 W, E27

88610 wie 88609, jedoch in weiß

88611 Schwarz, Aluminiumguss, klares Kathedralglas, mit Montageplatte, H. 43 cm, B. 23 cm, Ausl. 29 cm, IP23, LM 75 W, E27

88612 wie 88611, jedoch in weiß

88613 Schwarz, Aluminiumguss, klares Kathedralglas, H. 113 cm, B. 23 cm, IP23, LM 75 W, E27

88614 wie 88613, jedoch in weiß

88615 Schwarz, Aluminiumguss, Glas opal, H. 120 cm, B. 26 cm, Ausl. 33,5 cm, IP44, LM 75 W, E27

88616 Weiß, Aluminiumguss, Glas opal, H. 120 cm, B. 26 cm, Ausl. 33,5 cm, IP44, LM 75 W, E27

88617 Schwarz, Aluminiumguss, Glas opal, H. 36 cm, B. 26 cm, Ausl. 33,5 cm, IP44, LM 75 W, E27

88618 Weiß, Aluminiumguss, Glas opal, H. 36 cm, B. 26 cm, Ausl. 33,5 cm, IP44, LM 75 W, E27

88619 Schwarz, Aluminiumguss, mit 120° Bewegungsmelder, Glas opal, H. 42 cm, B. 26 cm, Ausl. 33,5 cm, IP44, LM 75 W, E27

88620 Weiß, Aluminiumguss, mit 120° Bewegungsmelder, Glas opal, H. 42 cm, B. 26 cm, Ausl. 33,5 cm, IP44, LM 75 W, E27

88621 Schwarz, Glas klar, H. 25,5 cm, Ø 27,5 cm, Ausl. 42 cm, IP54, LM 60 W, E27

88599
€ 139,95

ohne
Bewegungsmelder
88600
€ 94,95

88598
€ 172,95

88601
€ 94,95

88603
€ 459,95

88602
€ 139,95

Erdeinbausockel
88604
€ 89,95



schwarz
88611
€ 69,95

weiß
88612
€ 74,95

schwarz
88605
€ 384,95

weiß
88606
€ 389,95

schwarz
88607
€ 69,95

weiß
88608
€ 74,95

schwarz
88609
€ 89,95

weiß
88610
€ 89,95

schwarz
88613
€ 149,95

weiß
88614
€ 149,95

schwarz
88617
€ 99,95

weiß
88618
€ 94,95

schwarz
88619
€ 154,95

weiß
88620
€ 154,95

schwarz
88615
€ 184,95

weiß
88616
€ 199,95

Erdeinbausockel
88604
€ 89,95



88621
€ 45,95



☀ Serie auch in Edelstahl erhältlich



88622
€ 184,95



88623
€ 269,95



☀ Serie auch in Aluminium grau lackiert erhältlich



88624
€ 379,95



88625
€ 449,95



EDELSTAHL



88627
€ 134,95



88626
€ 219,95



88630
€ 239,95



88628
€ 319,95

mit Bewegungsmelder
88629
€ 419,95

Erdeinbausockel
88604
€ 89,95



88631
€ 199,95



88633
€ 179,95



88632
€ 229,95

Erdeinbausockel
88604
€ 89,95

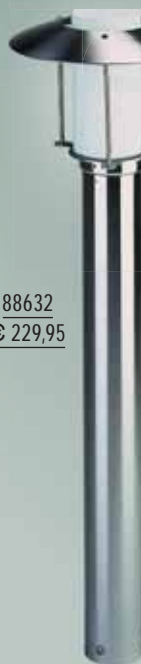

88622 Anthrazit, Glas opal, H. 28 cm, B. 28 cm, Ausl. 9,5 cm, IP44, LM 2x60 W, E27

88623 Anthrazit, Kunststoff Macrolon, H. 80 cm, L. 16 cm, B. 8 cm, IP44, LM TC-L 24 W, 2G11

88624 Rostfarbig, Aluminium-Druckguss, Methacrylat matt, mit zweifachem Lichtaustritt, L. 40 cm, Ausl. 20 cm, mit EVG, IP55, LM TC-L 18 W, 2G11

88625 Rostfarbig, Aluminium-Druckguss, Methacrylat matt, mit zweifachem Lichtaustritt, H. 110 cm, L. 17 cm, B. 6 cm, mit EVG, IP55, LM TC-L 18 W, 2G11

88626 Edelstahl, Glas opal, H. 90 cm, Ø 11 cm, IP44, LM 100 W, E27

88627 Edelstahl, Glas opal, H. 30 cm, Ø 11 cm, IP44, LM 100 W, E27

88628 Edelstahl, Glas opal, H. 90 cm, Ø 10,3 cm, IP44, LM 75 W, E27

88629 Edelstahl, Glas opal, mit 110° Bewegungsmelder, H. 90 cm, Ø 10,3 cm, IP44, LM 75 W, E27

88630 Edelstahl, Glas opal, mit Bewegungsmelder 120° Erfassung, H. 38 cm, Ausl. 17 cm, Ø 10,3 cm, IP44, LM 75 W, E27

88631 Edelstahl, Glas opal, H. 35,5 cm, Ausl. 17 cm, Ø 10,3 cm, IP44, mit Unterlicht PAR 20, 50 W und LM 75 W E27

88632 Edelstahl, Glas opal, H. 90 cm, B. 21 cm, IP44, LM 75 W, E27

88633 Edelstahl, Glas opal, H. 34,5 cm, B. 21 cm, Ausl. 25,5 cm, IP44, LM 75 W, E27

EDELSTAHL

88634 Edelstahl gebürstet, Kunststoff Macrolon, mit seitlichem Lichtaustritt, H. 35 cm, B. 17 cm, Ausl. 11 cm, LM 75 W, E27

88635 wie 88634, jedoch mit 150° Bewegungsmelder

88636 Edelstahl gebürstet, Glas opal, H. 28 cm, B. 16 cm, Ausl. 9 cm, IP44, LM 60 W, E27

88637 wie 88636, jedoch mit 150° Bewegungsmelder

88638 Edelstahl, Opalglass seidenmatt, mit 200° Bewegungsmelder, H. 30,5 cm, B. 19 cm, Ausl. 24 cm, IP44, LM 100 W, E27

88639 wie 88638, jedoch ohne Bewegungsmelder

88640 Edelstahl, Glas opal, L. 34 cm, B. 16 cm, Ausl. 8 cm, IP44, LM 40 W, G9, HV

88641 Edelstahl gebürstet, Glas satiniert, H. 28 cm, B. 18 cm, Ausl. 8 cm, IP 44, LM 75 W, E27

88642 wie 88641, jedoch mit 150° Bewegungsmelder

88643 Edelstahl gebürstet, Glas satiniert, H. 28 cm, B. 18 cm, Ausl. 8 cm, IP 44, LM 75 W, E27

88644 wie 88643, jedoch mit 150° Bewegungsmelder

88645 Edelstahl, Glas opal, H. 28 cm, B. 18 cm, Ausl. 10,5 cm, IP44, LM 75 W, E27

88646 Edelstahl, Glas opal, L. 33 cm, B. 32 cm, Ausl. 8 cm, IP44, LM 2x40 W, G9, HV

88647 Edelstahl, Glas opal, H. 26 cm, B. 26 cm, Ausl. 6 cm, IP54, LM 2x9 W, G23

88648 Edelstahl, Glas opal, L. 21 cm, B. 21 cm, Ausl. 7 cm, IP44, LM 2x40 W, G9, HV

88649 Edelstahl, mit doppeltem Lichtaustritt, H. 18 cm, Ø 6 cm, Ausl. 10 cm, IP54, inkl. LM 2x35 W, GU10, HV

88650 Edelstahl, Glas klar, H. 23 cm, Ø 23 cm, Ausl. 25 cm, IP54, LM 60 W, E27

88651 wie 88650, jedoch verzinkt

88652 Edelstahl, Glas klar, mit eingebautem 100° Sensor, H. 23 cm, Ø 23 cm, Ausl. 25 cm, IP54, LM 60 W, E27

88653 wie 88652, jedoch verzinkt

88654 Edelstahl, Glas klar, H. 100 cm, Ø 23 cm, IP54, LM 60 W, E27

88655 wie 88654, jedoch verzinkt

88656 Edelstahl, Opalglass, L. 23 cm, B. 25 cm, Ausl. 14 cm, IP44, LM 75 W, E27

88657 Edelstahl, Glas klar, H. 25,5 cm, Ø 27,5 cm, Ausl. 42 cm, IP54, LM 60 W, E27

mit 150° Bewegungsmelder

mit seitlichem Lichtaustritt

88634 € 134,95

mit 150° Bewegungsmelder

88635 € 199,95

mit 200° Bewegungsmelder

88636 € 124,95

mit 200° Bewegungsmelder

88637 € 184,95

88638 € 239,50

88639 € 169,50

88640 € 164,95

mit 150° Bewegungsmelder

88641 € 109,95

88642 € 174,95

88643 € 109,95

mit 150° Bewegungsmelder

88644 € 169,95

88645 € 147,50

88646 € 224,95

88647 € 214,95

88648 € 148,95

88649 € 32,95

Edelstahl 88650 € 41,95

verzinkt 88651 € 36,95

Edelstahl 88652 € 53,95

verzinkt 88653 € 46,95

Edelstahl 88654 € 68,95

verzinkt 88655 € 65,95

Edelstahl 88656 € 84,50

88657 € 49,95